

OBE type Direct Operated Linear Servo Valves

On-board electronics (OBE) type direct operated linear servo valves are based on high speed linear servo valves (LSVG) and OBE type linear servo valves (LSVHG-*EH), providing "high accuracy, easiness to use, and great usability".

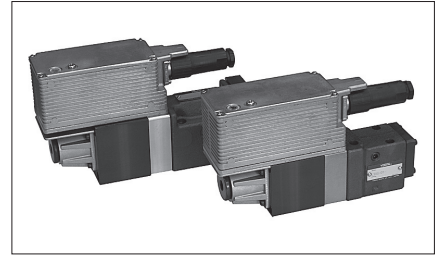

● **High accuracy**

As is the case with the high speed linear servo valves, all of the OBE type direct operated linear servo valves have a low hysteresis of 0.1 % or less, realizing high accuracy. These valves allow the main unit to operate with much higher repeatability.

● **High response characteristics**

Compared to other equivalent models, these valves provide higher levels of step and frequency responses, which are typically used as measures of response characteristics; the step response is 3 ms (0 <=> 100 %), and the frequency response is 260 Hz/-3 dB (± 25 % amplitude).

[★ : Representative values for LSVG-03EH with the Y port (dry type)]

● **Easiness to use**

These valves can offer high accuracy for hydraulic control systems just with 24 V DC power supply and command signal input.

Six types of input signals in three input voltage/current ranges are available: 0 - ±10 V, 0 - ±10 mA, and 4 - 20 mA.

● **Great usability**

The small amplifier in the valves has a fault indicator lamp. This lamp indicates an error when valve failure causes any deviation between the spool position commanded by the signal and the actual spool position. It facilitates you to immediately troubleshoot the failure of the valves, if any.

● **Excellent contamination resistance**

As is the case with the high speed linear servo valves, the OBE type direct operated linear servo valves have a simple pilot valve structure, exhibiting excellent contamination resistance. The permissible level of fluid contamination for these valves is up to NAS 1638 class 10.

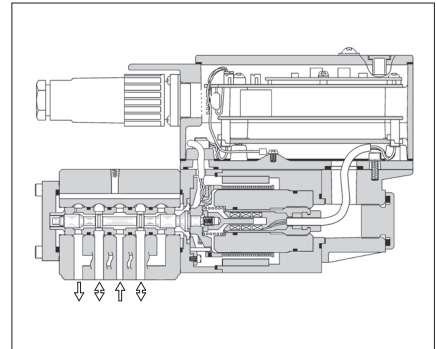

Graphic Symbols

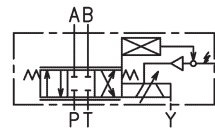

With Y Port (Dry Type)

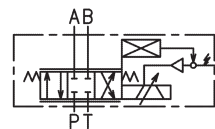

Without Y Port (Wet Type)

■ **Model Number Designation**

F-	LSVG	-03	EH	-60	-W	A	-A	1	-10
Fluid Type	Series Number	Valve Size	Amp. Type	Rated Flow @ ΔP=7MPa	Drain Port and Permissible Back Pres.	Fail-safe Function	Input Signal/Spool Travel Monitoring	Connector Type	Design Number
F : Special Seals for Phosphate Ester Type Fluid (Omit if not required)	LSVG : Direct Operated Linear Servo Valves	01	EH : OBE Type	4: 4 L/min	None: With Y Port (Permissible Back Pres.: 0.05 MPa) (Dry Type)	A: P→A→B→T Position B: P→B→A→T Position C:Neutral	A: Voltage Signal ±10 V (P→B→A→T Flow with Input Signal (+))	1: 6 + PE Pole 2:11 + PE Pole - With "Enable" Function - With "Valve Ready" Function - With "Alarm Output" Function	10
				10: 10 L/min			B: Current Signal 4 - 20 mA (P→B→A→T Flow with Current Signal 12 - 20 mA)		
		20: 20 L/min		W:Without Y Port★1 (Wet Type)	C: Current Signal ±10 mA (P→B→A→T Flow with Input Signal (+))				
		40: 40 L/min			D: Voltage Signal ±10 V (P→A→B→T Flow with Input Signal (+))				
03	60: 60 L/min		E: Current Signal 4 - 20 mA (P→A→B→T Flow with Current Signal 12 - 20 mA)		F: Current Signal ±10 mA (P→A→B→T Flow with Input Signal (+))		10★2		

★ 1. For the wet type, water-glycol fluids cannot be used.

★ 2. We prepare mounting bolt M6 specified application-designed product. Maximum pressure of this product is limited, for details please contact us.

Specifications The values in parentheses in the specification table below are applicable to the models “LSVG-*EH-*-W*-*” (wet type).

Model Numbers		LSVG-01EH-4-*	LSVG-01EH-10-*	LSVG-01EH-20-*	LSVG-03EH-40-*	LSVG-03EH-60-*
Descriptions						
Rated Flow at $\Delta P = 7 \text{ MPa}$ ⁽¹⁾	L/min	4	10	20	40	60
Max. Operating Pressure	MPa	35				
Proof Pres. at Return Port	MPa	21 (7)			35 (7)	
Drain Port (Y Port) Permissible Back Pres. ⁽²⁾	MPa	0.05 (No Y Port for Wet Type)				
Internal Leakage ($P_s = 14 \text{ MPa}$ Max. Leakage Viscosity: $32 \text{ mm}^2/\text{s}$)	L/min	0.4 or less	0.8 or less	1.2 or less	1.7 or less	
Hysteresis	%	0.1 or less				
Step Response (Typical) ⁽³⁾ ($P_2 = 14 \text{ MPa}$ ($0 \leftrightarrow 100 \%$))	ms	3 (3.5)				4 (4.5)
Frequency Response ($\pm 25 \%$ Amplitude) (Typical) ⁽³⁾	Gain: -3 dB	240 (230)		260 (240)	250 (220)	
	Phase: -90°	300 (270)		310 (310)	260 (220)	
Vibration Proof	m/s^2	100				
Protection		IP 65				
Ambient Temperature	$^\circ\text{C}$	0 - + 50				
Spool Stroke to Stops	mm	± 0.5				± 0.75
Polarity		See the description about I/O signal characteristics on page I-24.				
Linear Motor Specification	Current	1.5 (Max. 3.2)				
	Coil Resistance	7 [at $20 \text{ }^\circ\text{C}$]				
Approx. Mass	kg	4.3			5.2	
Electric Connection		6 + PE/11 + PE Connector				

Note) ⁽¹⁾ Use the valves so that the relationship between the valve pressure difference and the flow rate, as specified below in “Range of Flow Control”, is met.

⁽²⁾ Back pressure at the drain port (Y) should be 0.05 MPa or less and not be a negative pressure.

⁽³⁾ This value is measured for each valve; it may vary depending on the actual circuit/operation conditions.

Accessories

Mounting Bolts

Model Numbers	Mounting Bolt	Qty.	Bolt Tightening Torque
LSVG-01EH	Hex. Soc. Head Cap Screw : M5 x 55 L	4	6.0 - 8.0 Nm
LSVG-03EH-*10	Hex. Soc. Head Cap Screw : M8 x 65 L	4	30.8 - 37.7 Nm

Connector

Model Numbers	Connector	Qty.	Remarks
LSVG-*EH- -*-*1	6 + PE Electrical Plug	1	Compatible with EN 175201 PART 804
LSVG-*EH- -*-*2	11 + PE Electrical Plug	1	

Cable with Connector (Separately Available)

Model Numbers	Connector	Cable Model Numbers	Remarks
LSVG-*EH- -*-*1	6 + PE Electrical Plug	LSVC-6PE- -*11	* Cable Length 03 : 3 m 05 : 5 m 10 : 10 m
LSVG-*EH- -*-*2	11 + PE Electrical Plug	LSVC-11PE- -*11	

The cable with a connector is a cable assembly that includes the same connector as the one supplied with the valves.

Range of Flow Control

Control Method: 4-Way Valve

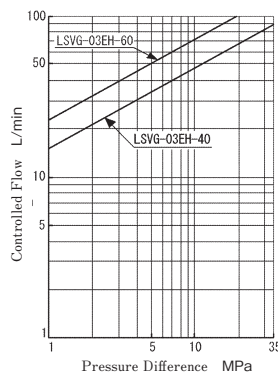
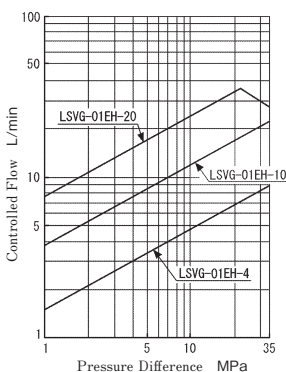

Control Method: 3-Way Valve

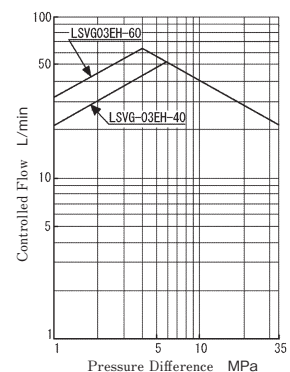
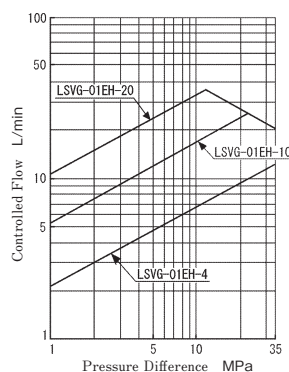

Electrical Specifications

● 6 + PE Connector

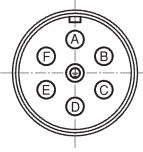

Pin		Valve Model		
		LSVG-*EH-*-A1 LSVG-*EH-*-D1	LSVG-*EH-*-B1 LSVG-*EH-*-E1	LSVG-*EH-*-C1 LSVG-*EH-*-F1
Pin A	Power Supply	24 V DC (21.6 - 26.4 V DC Included Ripple), 100 VA or more		
Pin B		0 V		
Pin C	Signal Common	COM(0 V)		
Pin D	Input (+) (Differential) ^{★1}	0 - ±10 V Ri=100 kΩ	4 - 20 mA Ri=200 Ω	0 - ±10 mA Ri=200 Ω
Pin E	Input (-) (Differential) ^{★1}			
Pin F	Spool Travel Monitoring	0 - ±10 V R _L ≥ 10 kΩ	4 - 20 mA R _L = 100 - 500 Ω ^{★2}	0 - ±10 mA R _L = 100 - 500 Ω ^{★2}
Pin	Protective Earth	-		

● 11 + PE Connector

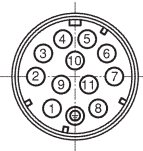

Pin		Valve Model		
		LSVG-*EH-*-A2 LSVG-*EH-*-D2	LSVG-*EH-*-B2 LSVG-*EH-*-E2	LSVG-*EH-*-C2 LSVG-*EH-*-F2
Pin 1	Power Supply	24 V DC (21.6 - 26.4 V DC Included Ripple), 100 VA or more		
Pin 2		0 V		
Pin 3	Enable (Servo ON) Input	Input Current = 3 - 5 mA at 4.8 - 28 V DC		
Pin 4	Input (+) (Differential) ^{★1}	0 - ±10 V Ri=100 kΩ	4 - 20 mA Ri=200 Ω	0 - ±10 mA Ri=200 Ω
Pin 5	Input (-) (Differential) ^{★1}			
Pin 6	Spool Travel Monitoring	0 - ±10 V R _L ≥ 10 kΩ	4 - 20 mA R _L = 100 - 500 Ω ^{★2}	0 - ±10 mA R _L = 100 - 500 Ω ^{★2}
Pin 7	Signal Common	COM (0 V)		
Pin 8	Valve Ready Output	Open Collector Output Voltage: Max. 30 V, Current: Max. 20 mA		
Pin 9	-	-		
Pin 10	-	-		
Pin 11	Alarm Output	Open Collector Output Voltage: Max. 30 V, Current: Max. 20 mA		
Pin	Protective Earth	-		

★1. Differential input signals can be used only for the valves with the voltage signal specifications of ±10 V (LSVG-*EH-*-A*/D*).

★2. The recommended load resistance is 200 Ω.

● I/O Signal Characteristics

· LSVG-*EH-*-A*/B*/C*

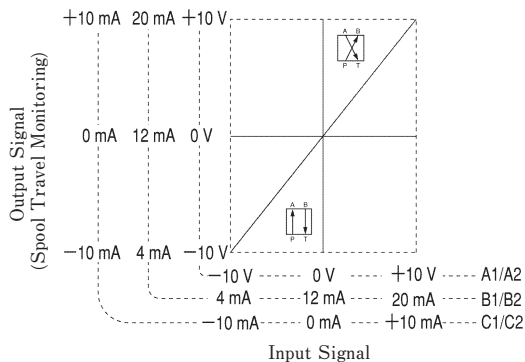

· LSVG-*EH-*-D*/E*/F*

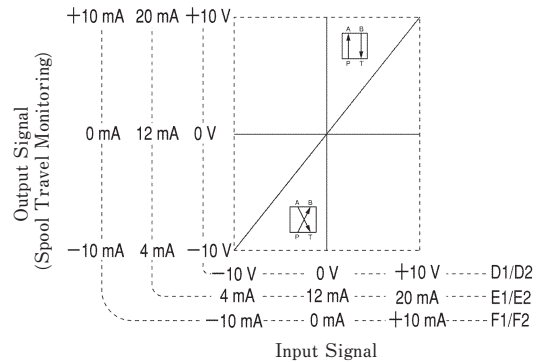

Block Diagram

● LSVG-*EH-*-* *-A1/B1/C1/D1/E1/F1 (6 + PE Connector)

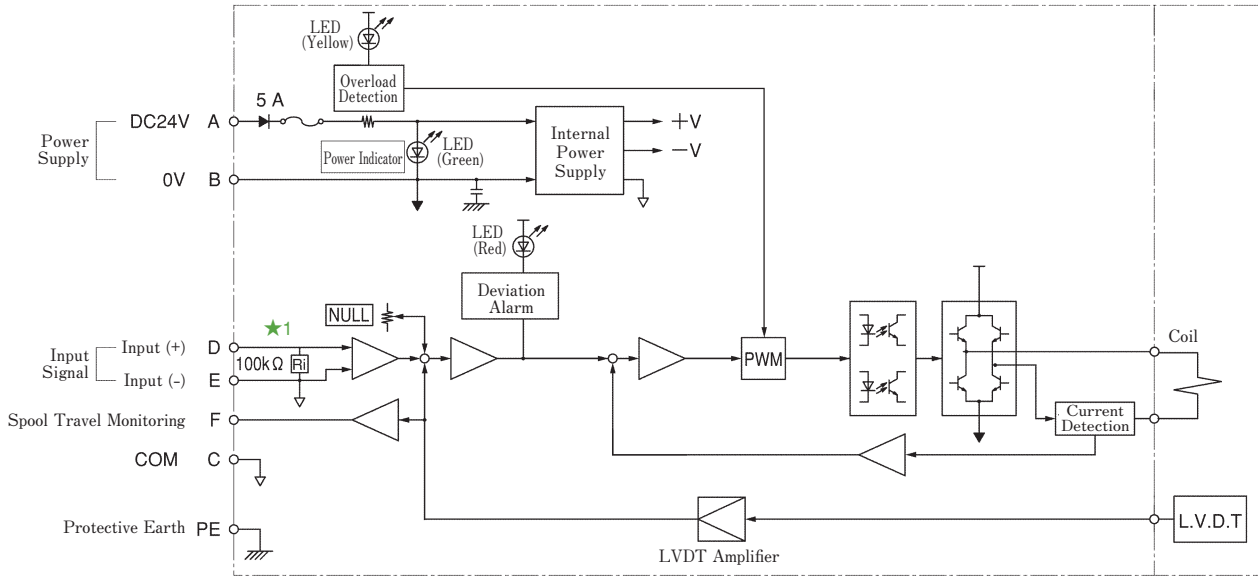

★1. The input stage for the models LSVG-*EH-*-* *-B1/C1/E1/F1 (current signal) is as follows.

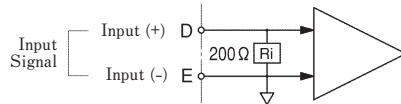

● LSVG-*EH-*-* *-A2/B2/C2/D2/E2/F2 (11 + PE Connector)

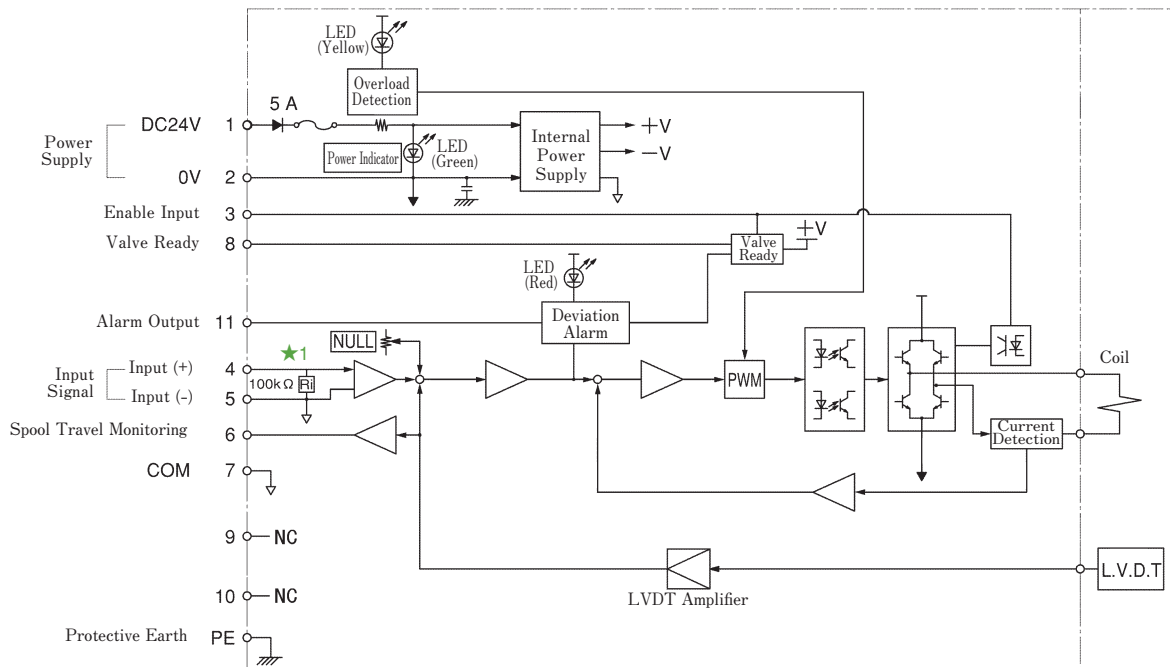

★1. The input stage for the models LSVG-*EH-*-* *-B2/C2/E2/F2 (current signal) is as follows.

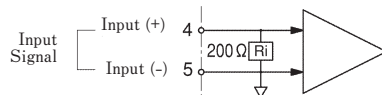

LSVG-01EH

Mounting Surface: Conforming to ISO 4401-03-02-0-05

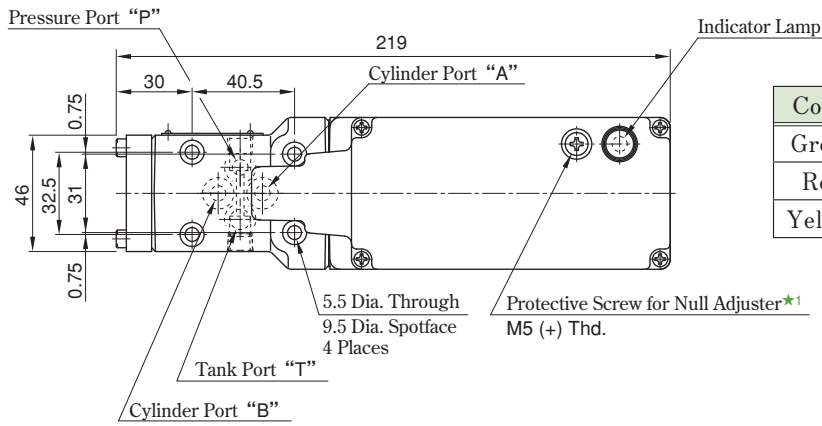

Color	Indicator Lamp
Green	Power Supply
Red	Deviation Alarm
Yellow	Overload

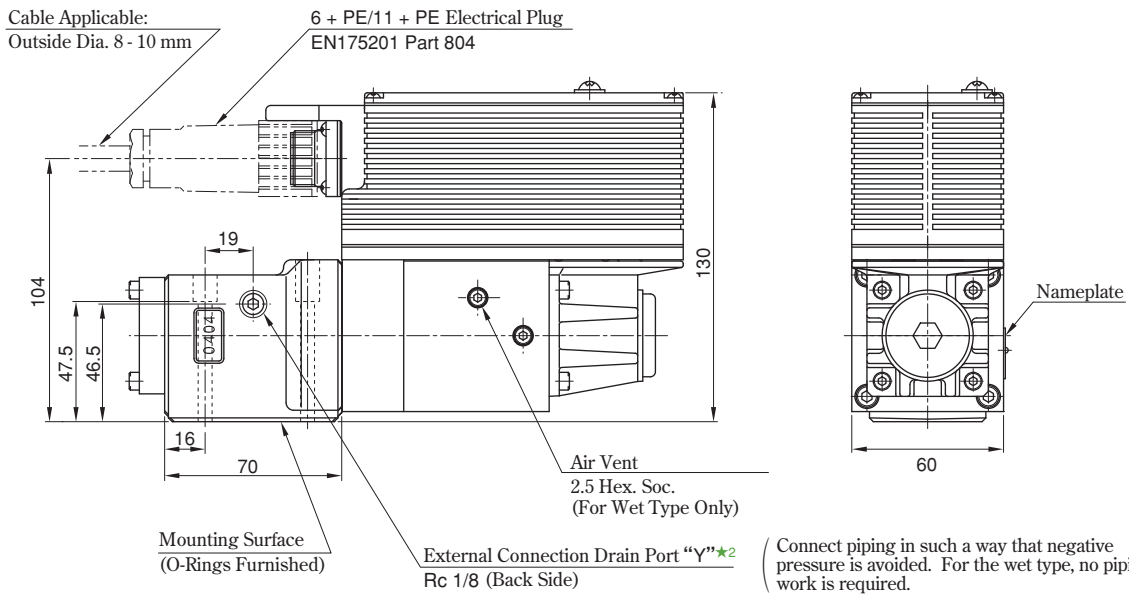

(Connect piping in such a way that negative pressure is avoided. For the wet type, no piping work is required.)

- ★1. To adjust the null, remove the protective screw and turn the null trimmer. After adjustment, be sure to attach the protective screw.
- ★2. For the dry type, the external connection drain port "Y" on the tank port side is usually plugged. To use the port on the tank port side, remove the hexagon socket head plug (5 Hex.) from the drain port on the tank port side and plug the port on the pressure port side.

● O-Rings for the Ports

AS568-012 (NBR-90) : 4 pieces

O-rings made of fluorinated rubber are required to use phosphate ester type fluids.

● Dimensions of Mounting Surface

Prepare a mounting surface shown below. Basically, the dimensions of the mounting surface conform to the ISO standard.

The mounting surface should have a good machined finish. $\sqrt{6}$

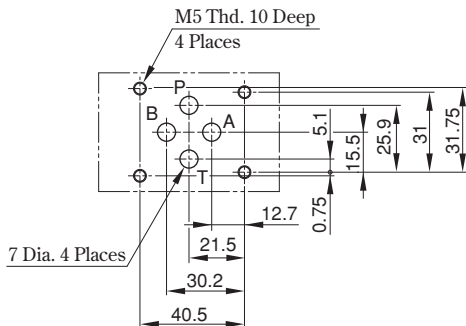

LSVG-03EH

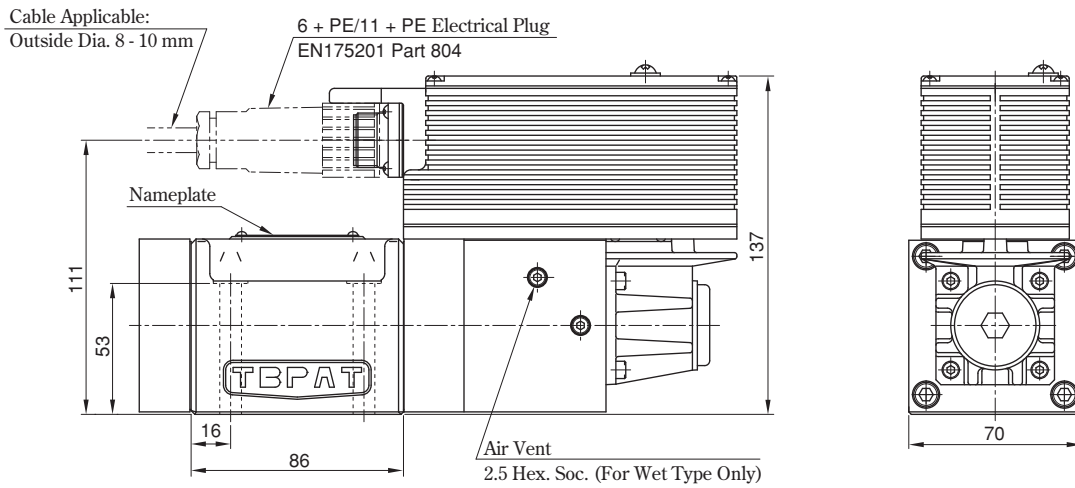
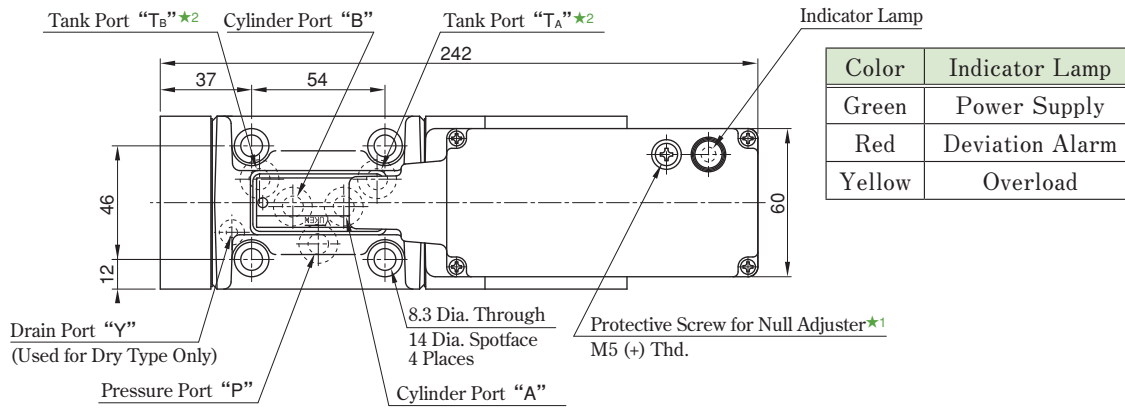

★1. To adjust the null, remove the protective screw and turn the null trimmer. After adjustment, be sure to attach the protective screw.

● O-Rings for the Ports

Port	O-Ring Size	Qty.
P, A, B, T	AS568-014 (NBR-90)	5
Y	OR NBR-90 P7-N	1

O-rings made of fluorinated rubber are required to use phosphate ester type fluids.

● Dimensions of Mounting Surface

Prepare a mounting surface shown on the right. Basically, the dimensions of the mounting surface conform to the ISO standard, but the specifications for the valve mounting screws and the drain port "Y" (for the dry type) are different as follows.

	ISO 4401-05-04-0-05	Mounting Surface for LSVG-03EH-* -10
Valve Mounting Screw	M6	M8
Drain Port "Y" (For Dry Type)	Without "Y" Port	With "Y" Port

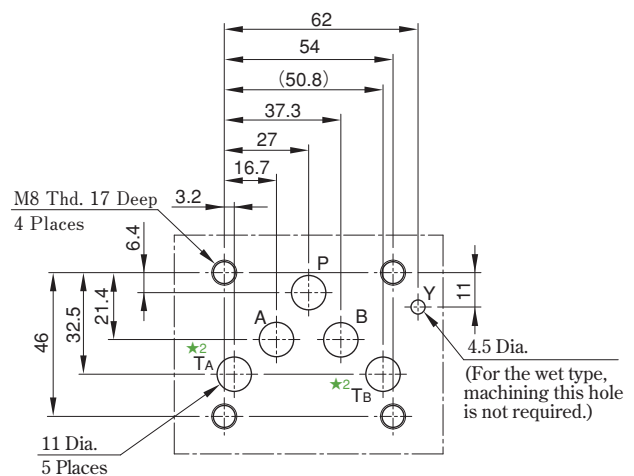

★2. There are two tank ports "TA" and "TB"; however, "TA" may be used alone.

Characteristics of LSVG-01EH-4/10/20 (Fluid Viscosity: 30 mm²/s)

No-Load Flow Characteristics

<Conditions>

● Valve Pressure Difference : 7 MPa

Flow: P→B→A→T★
(P→A→B→T)

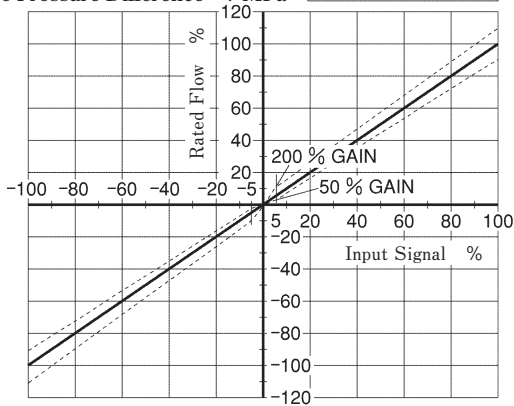

Flow: P→A→B→T★
(P→B→A→T)

★ The flow outside of parentheses is achieved when the input signal type "A", "B", or "C" is selected. The flow in parentheses is achieved when "D", "E", or "F" is selected.

Load Flow Characteristics

<Conditions> ● Input Signal : 100 %

Note) Tolerance for Load Flow : ±10 %

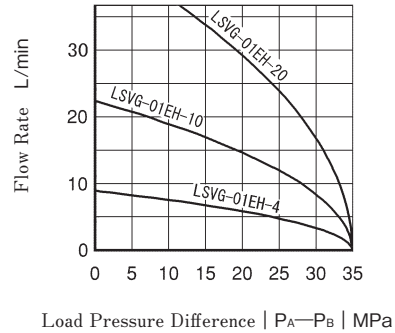

Step Response

<Conditions> ● Input Amplitude : 0 ⇔ 100 % ● Supply Pressure : 14 MPa

● LSVG-01EH-4/10/20-**-10 (Dry Type)

● LSVG-01EH-4/10/20-W**-10 (Wet Type)

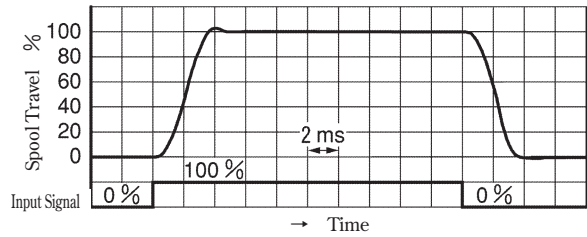
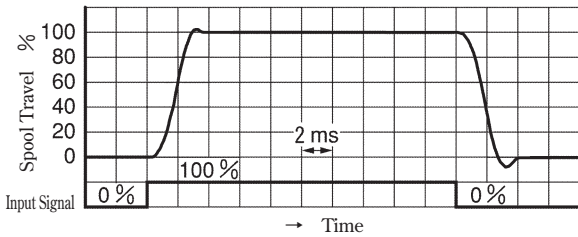

Frequency Response

<Conditions> ● Hydraulic Circuit: Port A/B Closed ● Supply Pressure : 14 MPa

● LSVG-01EH-4/10/20-**-10 (Dry Type)

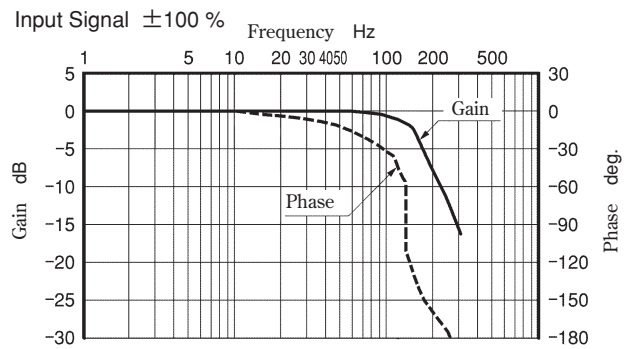
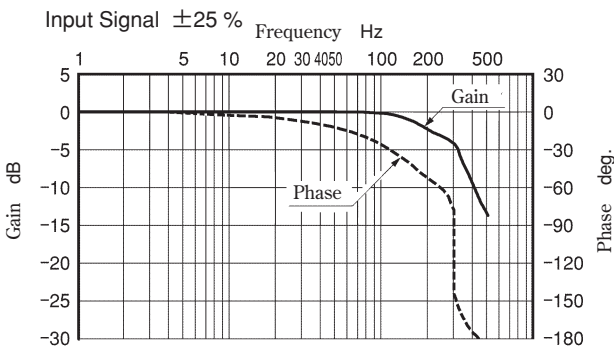

● LSVG-01EH-4/10/20-W**-10 (Wet Type)

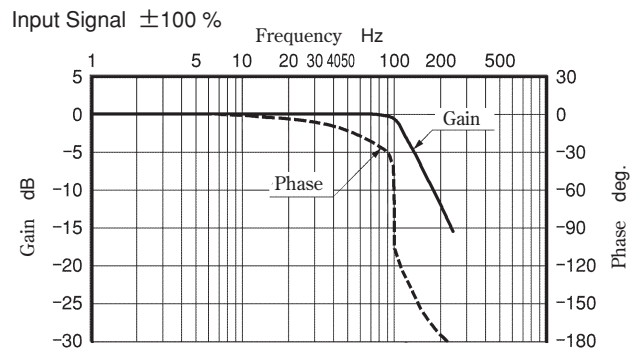
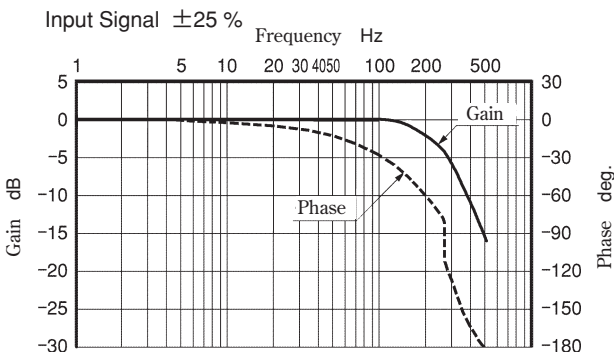

Characteristics of LSVG-03EH-40/60 (Fluid Viscosity: 30 mm²/s)

No-Load Flow Characteristics

<Conditions>

● Valve Pressure Difference : 7 MPa

Flow: P→B→A→T ★
(P→A→B→T)

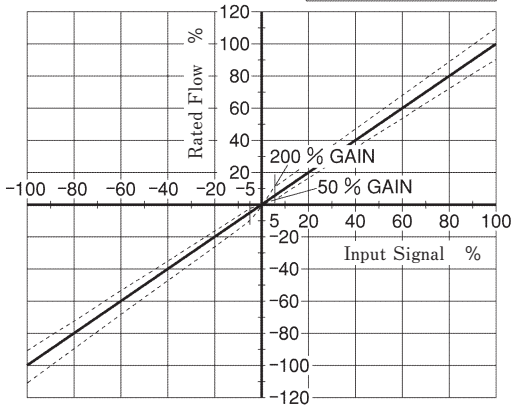

Flow: P→A→B→T ★
(P→B→A→T)

★ The flow outside of parentheses is achieved when the input signal type "A", "B", or "C" is selected. The flow in parentheses is achieved when "D", "E", or "F" is selected.

Load Flow Characteristics

<Conditions> ● Input Signal : 100 %

Note) Tolerance for Load Flow : ±10 %

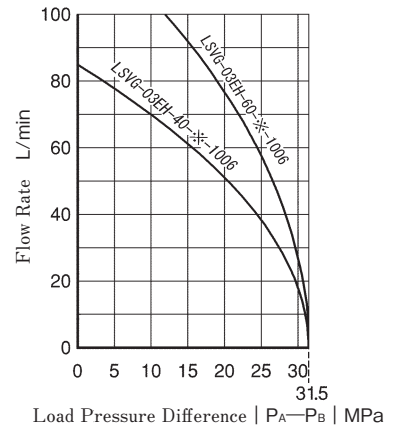
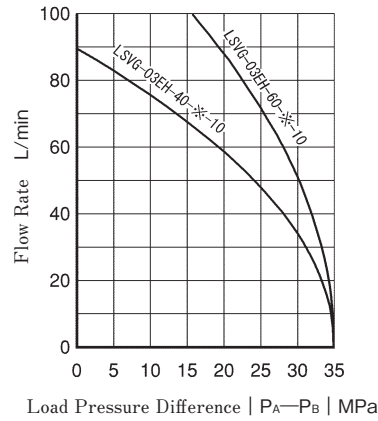

Step Response

<Conditions> ● Input Amplitude : 0 ⇔ 100 % ● Supply Pressure : 14 MPa

● LSVG-03EH-40-**-10 (Dry Type)

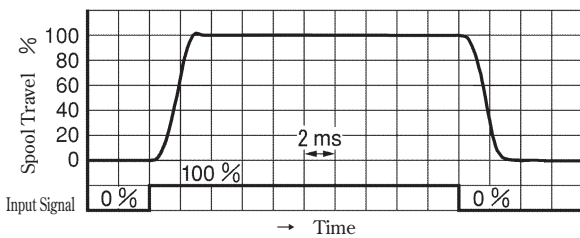

● LSVG-03EH-40-W**-10 (Wet Type)

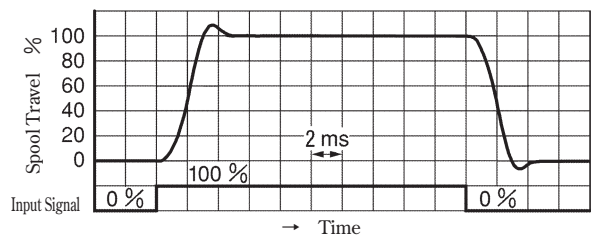

● LSVG-03EH-60-**-10 (Dry Type)

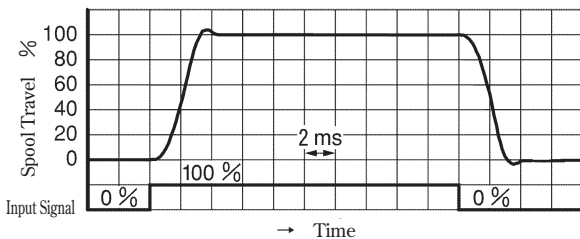

● LSVG-03EH-60-W**-10 (Wet Type)

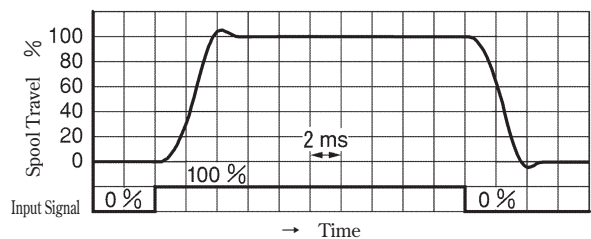

Frequency Response

<Conditions> ● Hydraulic Circuit: Port A/B Closed ● Supply Pressure : 14 MPa

● LSVG-03EH-40-**-**-10 (Dry Type)

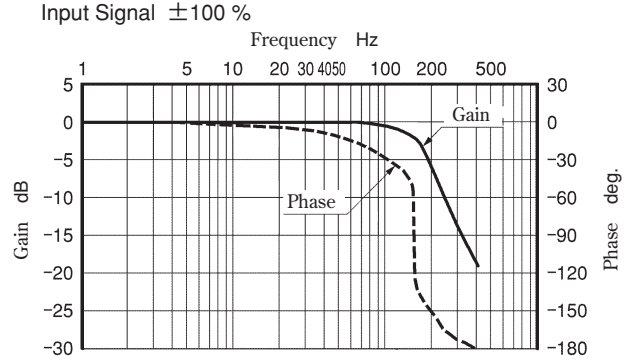
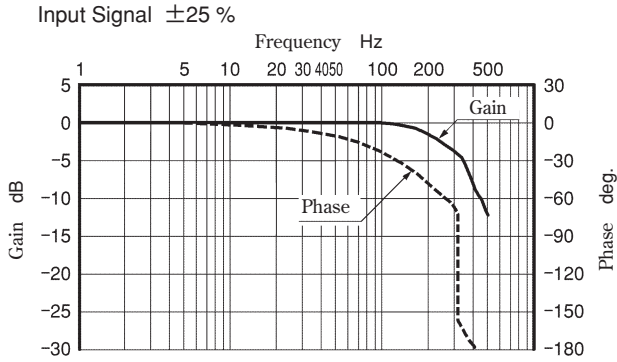

● LSVG-03EH-40-W**-**-10 (Wet Type)

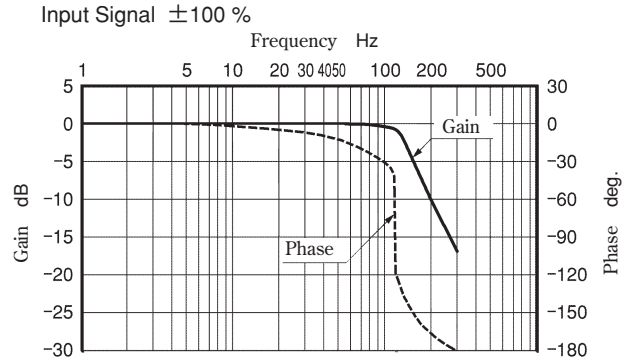
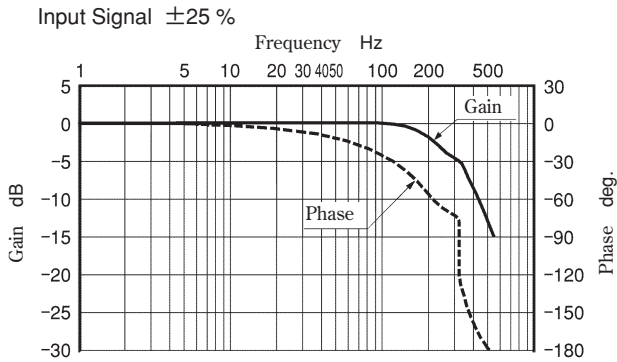

● LSVG-03EH-60-**-**-10 (Dry Type)

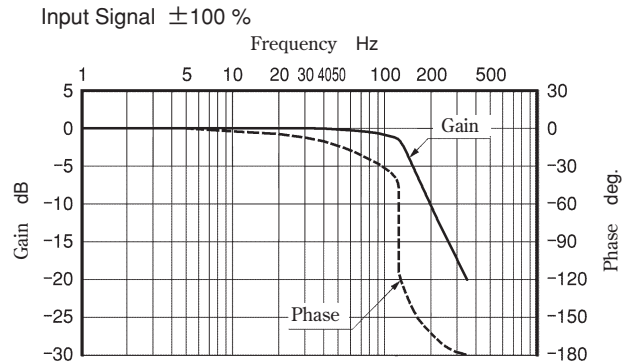
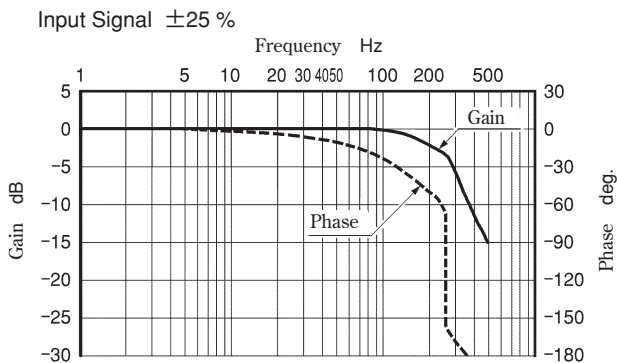

● LSVG-03EH-60-W**-**-10 (Wet Type)

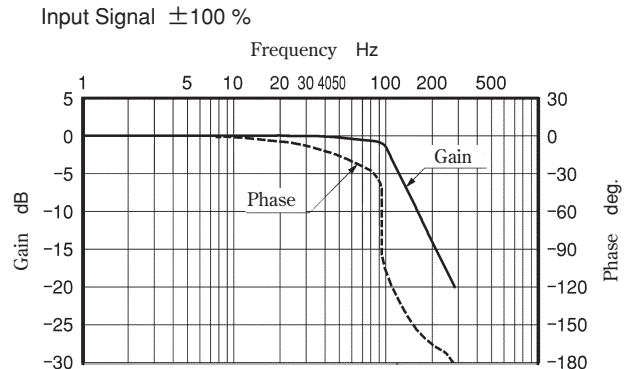
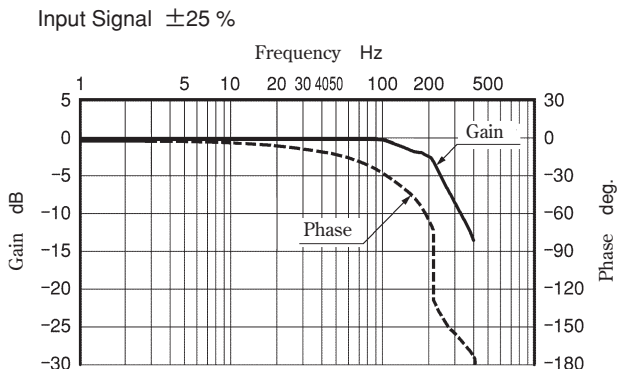

OBE(On-Board Electronics) Type Linear Servo Valves (Std. Type)

On-board electronics (OBE) type linear servo valves have been developed based on two stage type high speed linear servo valves, but with a focus on downsizing the pilot valve. The integration of the exclusive amplifier and the linear servo valve in a compact package provides “high accuracy, easiness to use, and great usability”.

- High accuracy

As is the case with the high speed linear servo valves, all of the OBE type linear servo valves have a low hysteresis of 0.1 % or less, realizing high accuracy. These valves allow the main unit to operate with much higher repeatability.

- High response characteristics

Compared to other equivalent models, these valves provide higher levels of step and frequency responses, which are typically used as measures of response characteristics; the step response is 7 ms (0 <=> 100 %)★, and the frequency response is 125 Hz/-3 dB (± 25 % amplitude)★. (★ : Representative values for LSVHG-03EH)

- Easiness to use

These valves can offer high accuracy for hydraulic control systems just with 24 V DC power supply and command signal input.

Six types of input signals in three input voltage/current ranges are available: 0 - ±10 V, 0 - ±10 mA, and 4 - 20 mA.

- Great usability

The small amplifier in the valves has a fault indicator lamp. This lamp indicates an error when valve failure causes any deviation between the spool position commanded by the signal and the actual spool position. It facilitates you to immediately troubleshoot the failure of the valves, if any.

- Two types of pilot valves available

There are two types of pilot valves available: a dry type good in response characteristics and a wet type that eliminates the drain (DR) port to improve usability. They can be selected according to users' purposes.

- Excellent contamination resistance

As is the case with the high speed linear servo valves, the OBE type linear servo valves have a simple pilot valve structure, exhibiting excellent contamination resistance. The permissible level of fluid contamination for these valves is up to NAS 1638 class 10.

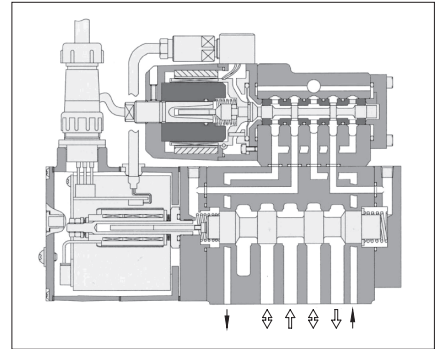
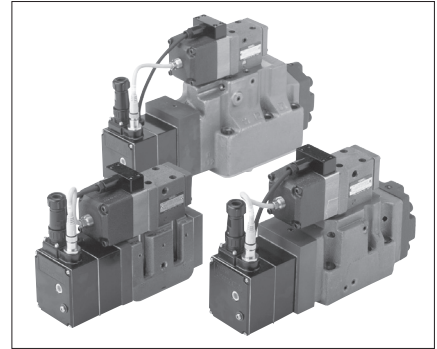

Graphic Symbols

- Spool Types “2”, “2P”, and “2L”

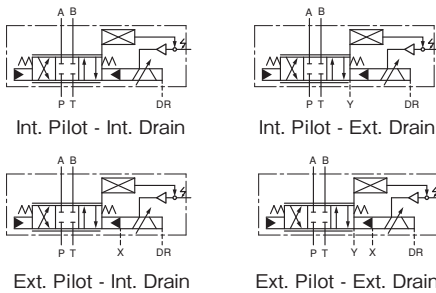

- Spool Type “40”

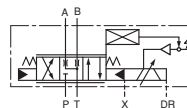

- Spool Type “4J”

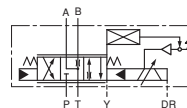

The symbols above indicate the external pilot/internal drain type. The internal pilot/internal drain type is the same as that for the spool types “2”, “2P”, and “2L”.

Input Signal/Spool Travel Monitoring “D”/“E”/“F”

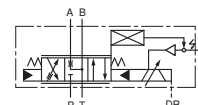

The pilot and drain types are the same as those for the input signal/spool travel monitoring “A”/“B”/“C”.

- Detailed Graphic Symbols (With Fail-safe Solenoid Operated Valve)

LSVHG-03/04EH-**-**EA/*EB/*EC

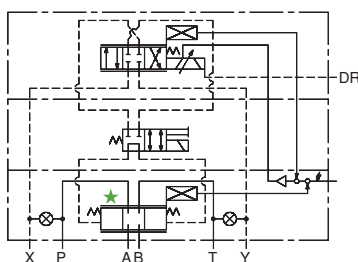

LSVHG-06/10EH-**-**EA/*EB/*EC

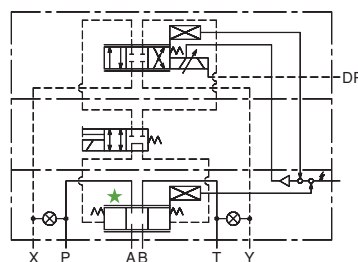

⊗ : Plugs for selecting the pilot and drain types
 ★ : Depending on the spool type.
 (Same as the graphic symbols shown above)

Model Number Designation

F-	LSVHG	-06	EH	-900	-2P	-E	T	-W	A	-A	1	-20													
Fluid Type	Series Number	Valve Size	Amp. Type	Rated Flow @ $\Delta P = 7 \text{ MPa}$	Spool Type	Pilot Type	Drain Type	DR Port and Permissible Back Pres.	Fail-safe Function	Input Signal/Spool Travel Monitoring	Connector Type	Design Number													
F: Special Seals for Phosphate Ester Type Fluid (Omit if not required)	LSVHG: Two Stage Type Linear Servo Valves	03	EH: OBE Type	230: 230 L/min	2L	None: Internal Pilot	None: External Drain	None: With DR Port (Permissible Back Pres.: 0.05 MPa) (Dry Type Pilot Valve)	None: P→B→A→T Position Valve Opening: Full	A: Voltage Signal ±10 V (P→B→A→T Flow with Input Signal (+))	1: PE Pole	20													
				270: 270 L/min	2, 40, 2P																				
				210: ^{*4} 210 L/min	4J:Open Center A, B & T																				
		04		750: 750 L/min	2L: 2% Overlap (Linear Flow Gain)								E: External Pilot	T: Internal Drain	W: ^{*2} Without DR Port (Wet Type Pilot Valve)	None: With Solenoid Operated Valve P→A→B→T Position Valve Opening: 10%	EA: With Solenoid Operated Valve P→A→B→T Position Valve Opening: 10%	EB: With Solenoid Operated Valve P→B→A→T Position Valve Opening: 10%	EC: With Solenoid Operated Valve Neutral Position	B: Current Signal 4 - 20 mA (P→B→A→T Flow with Current Signal 12 - 20 mA)	C: Current Signal ±10 mA (P→A→B→T Flow with Input Signal (+))	D: Voltage Signal ±10 V (P→A→B→T Flow with Input Signal (+))	E: Current Signal 4 - 20 mA (P→A→B→T Flow with Current Signal 12 - 20 mA)	F: Current Signal ±10 mA (P→A→B→T Flow with Input Signal (+))	
				580: ^{*4} 580 L/min	4J:Open Center A, B & T																				
				900: 900 L/min 1300: 1300 L/min	2, 40, 2P 2L: 2% Overlap (Linear Flow Gain)																				
		06		820: ^{*4} 820 L/min 1300: 1300 L/min	4J:Open Center A, B & T																				
				10	3800: 3800 L/min																				2, 40, 2P 2L: 2% Overlap (Linear Flow Gain)

- ★ 1. The available combinations of the spool type, fail-safe function, and input signal/spool travel monitoring are limited. For details, see the chart on the right.
- ★ 2. The valves with the model number “W” (without DR port) cannot use water-glycol fluids.
- ★ 3. For the valves with the fail-safe function “EC”, select “2” only for the connector type.
- ★ 4. For the spool type “4J”, the rated flow is a value obtained with +100% input and P → A flow (input signal/spool travel monitoring “A”, “B”, and “C”) or P → B flow (“D”, “E”, and “F”).
- ★ 5. For the spool function in the neutral position, see the chart below.

Spool Type	Fail-safe Function	Input Signal/Spool Travel Monitoring
2	With Solenoid Operated Valve: EC	All (A, B, C, D, E, F)
40	Without Solenoid Operated Valve: None/A	
2L	With Solenoid Operated Valve: EA/EB	
2P	Without Solenoid Operated Valve: None/A	
4J	With Solenoid Operated Valve: EC	D, E, F
	Without Solenoid Operated Valve: None	A, B, C
	Without Solenoid Operated Valve: A	

Spool Function in Neutral Position

Spool Type	Function
2, 2P, 2L	
40	
4J	

Fail-safe Function of the Valves

With reference to the information given below, select the option for the fail-safe function according to the use of applications. The valves have a fail-safe function, but a separate safety circuit should be provided if the hydraulic actuator must be reliably held or stopped to ensure safety in the event of electric failure (power failure, power cable disconnection, etc.) or upon startup.

1) Electric System: OFF and Hydraulic System: ON (Power Failure/Power Cable Disconnection)

No.	Model Numbers	Fail-safe Function*
1	(F-)LSVHG-**EH-*/2P/2L(-E)(T)(-W)	P→B→A→T Position Valve Opening: Full
2	(F-)LSVHG-**EH-*/2P/2L(-E)(T)(-W)A	P→A→B→T Position Valve Opening: Full
3	(F-)LSVHG-**EH-*/4J(-E)(T)(-W)	P→B→A→T Position Valve Opening: Full
4	(F-)LSVHG-**EH-*/4J(-E)(T)(-W)A	P→A→B→T Position Valve Opening: Full
5	(F-)LSVHG-**EH-*/2P/2L(-E)(T)(-W)EA (With Fail-safe Solenoid Operated Valve)	P→A→B→T Position Valve Opening: 10%
6	(F-)LSVHG-**EH-*/2P/2L(-E)(T)(-W)EB (With Fail-safe Solenoid Operated Valve)	P→B→A→T Position Valve Opening: 10%
7	(F-)LSVHG-**EH-*/4J(-E)(T)(-W)EC-A*/B*/C* (With Fail-safe Solenoid Operated Valve)	A, B, T Connection (Neutral)
8	(F-)LSVHG-**EH-*/4J(-E)(T)(-W)EC-D*/E*/F* (With Fail-safe Solenoid Operated Valve)	A, B, T Connection (Neutral)

★The fail-safe activation time depends on the electric and hydraulic conditions.

2) Electric System: OFF and Hydraulic System: OFF (Startup)

For Models No. 1 and 2 in the table above, the fail-safe function holds the spool in the neutral position. For Models No. 5 and 6, the function is the same as that for “Electric System: OFF and Hydraulic System: ON”. For Models No. 3, 4, 7, and 8, the function is based on A, B, T connection (neutral).

Specifications

LSVHG- *EH- * -2/40/2P/2L

The values in parentheses in the specification table below are applicable to the models “LSVHG- *EH- *- *- *-W *-” (without DR port).

Model Numbers			LSVHG- 03EH-230-*	LSVHG-03EH -270-*	LSVHG-04EH -750-*	LSVHG-06EH -900-*	LSVHG-06EH -1300-*	LSVHG-10EH -3800-*																
Descriptions																								
Spool Type			2 L	2 40 2P	2 40 2P 2 L	2 40 2P 2 L	2 40 2P 2 L	2 40 2P 2 L																
Rated Flow at $\Delta P = 7$ MPa (4-Way Valve) L/min			230	270	750	900	1300	3800																
Rated Flow at $\Delta P' = 0.5$ MPa (per Land) L/min			87	102	283	340	490	1440																
Max. Operating Pressure MPa			31.5		35	35	31.5	35																
Proof Pres. at Return Port ⁽¹⁾	External Drain	T Port MPa	21 ⁽⁵⁾		31.5	35	25	28																
		Y Port MPa	21 (7) ⁽⁵⁾		21 (7)																			
	Internal Drain	T & Y Ports MPa	21 (7) ⁽⁵⁾		21 (7)																			
DR Port Permissible Back Pressure ⁽²⁾ MPa			0.05 (The valves with the model number “W” have no DR port.)																					
Pilot Pressure ⁽³⁾ MPa			1.5 - 21																					
Pilot Flow Rate ⁽⁴⁾ L/min			9 (8) or more		20 (17) or more	22 (19) or more	23 (19) or more	28 (24) or more																
Pilot Valve Max. Leakage	Pres.: $P_s = P_p = 14$ MPa	L/min	0.8			1.2																		
			1.6	0.5	1	5.6	0.8	1.6	6.8	2.5	0.9	1.8	7	2.5	1	2	8	2.5	3	6	10	8		
Main Valve Max. Leakage	Max. Leakage	Viscosity: 32 mm ² /s																						
Hysteresis %			0.1 or less																					
Step Response (0 \leftrightarrow 100 %, Typical) ⁽⁶⁾ ms			8 (10)	7 (9)	11 (13)	11 (13)	15 (18)	18 (20)																
Frequency Response (± 25 % Amplitude, Typical) ⁽⁶⁾	Gain: -3 dB	Hz	120 (100)	125 (110)	100 (90)	100 (90)	75 (70)	60 (55)																
	Phase: -90°	Hz	110 (90)	110 (100)	90 (90)	90 (90)	70 (75)	70 (60)																
Vibration Proof ⁽⁷⁾ m/s ²			100																					
Protection			IP 65																					
Ambient Temperature °C			0 - +50																					
Spool Stroke to Stops mm			± 4	± 3.5	± 5	± 5	± 7	± 7																
Spool End Area cm ²			3		7	8	8	11.3																
Polarity			See the description about I/O signal characteristics on page I-36.																					
Linear Motor Specification	Current	A	Max. 2.1																					
	Coil Resistance	Ω	9.6 [at 20 °C]																					
Approx. Mass ⁽⁸⁾ kg			8.5 [11]			14 [16]	20 [24]	20 [24]	77															
Electric Connection			6 + PE/11 + PE Connector [EN175201 Part 804]																					

Note) ⁽¹⁾ Pressure at the return port should be at actual supply pressure or less.

⁽²⁾ Back pressure at the drain port should be 0.05 MPa or less and not be a negative pressure.

⁽³⁾ Supply pressure for the pilot valve should be 1.5 - 21 MPa and should also be 60 % of actual supply pressure or more.

⁽⁴⁾ The pilot flow is calculated based on a pilot pressure of 14 MPa and the above step response.

⁽⁵⁾ To use an external pilot type valve with a supply pressure of 21 MPa or more, pressures at the T and Y ports should be 7 MPa or less.

⁽⁶⁾ This value is measured for each valve based on a pilot pressure of 14 MPa; it may vary depending on the actual circuit/operation conditions.

⁽⁷⁾ There are restrictions on the mounting position; refer to the instructions for details.

⁽⁸⁾ A value in brackets indicates the mass of each valve with a fail-safe solenoid operated valve.

⁽⁹⁾ For the effective range of the fail-safe function, see page I-60.

Specifications

LSVHG- *EH- * -4J- * -A * /B * /C *

The values in parentheses in the specification table below are applicable to the models “LSVHG- *EH- * - * - * - *EH-W * -” (without DR port).

Model Numbers		LSVHG-03EH-210 -4J- * -A * /B * /C *	LSVHG-04EH-580 -4J- * -A * /B * /C *	LSVHG-06EH-820 -4J- * -A * /B * /C *	LSVHG-06EH-1300 -4J- * -A * /B * /C *		
Descriptions							
Spool Type		4J: Open Center A, B & T P→B Flow: 10 % Overlap, A→T Flow: 50 % Underlap P→A Flow: 60 % Overlap, B→T Flow: 5 % Underlap					
Rated Flow (±10%)	ΔP = 3.5 MPa (per Land)	L/min	P→B Flow: 210 A→T Flow: 235 P→A Flow: 95 B→T Flow: 240	P→B Flow: 580 A→T Flow: 675 P→A Flow: 255 B→T Flow: 660	P→B Flow: 820 A→T Flow: 950 P→A Flow: 370 B→T Flow: 940	P→B Flow: 1300 A→T Flow: 1440 P→A Flow: 660 B→T Flow: 1375	
	ΔP = 0.5 MPa (per Land)	L/min	P→B Flow: 79 A→T Flow: 89 P→A Flow: 36 B→T Flow: 91	P→B Flow: 219 A→T Flow: 255 P→A Flow: 96 B→T Flow: 249	P→B Flow: 310 A→T Flow: 359 P→A Flow: 140 B→T Flow: 355	P→B Flow: 491 A→T Flow: 544 P→A Flow: 249 B→T Flow: 520	
Max. Operating Pressure		MPa	31.5	35	35	31.5	
Proof Pres. at Return Port ⁽¹⁾	External Drain	T Port	MPa	21	31.5	35	25
		Y Port	MPa	21 (7)			
	Internal Drain	T & Y Ports	MPa	21 (7)			
DR Port Permissible Back Pressure ⁽²⁾		MPa	0.05 or less (The valves with the model number “W” have no DR port.)				
Pilot Pressure ⁽³⁾		MPa	1.5 - 21				
Pilot Flow Rate ⁽⁴⁾		L/min	9 (8) or more	20 (17) or more	22 (19) or more	23 (19) or more	
Pilot Valve Max. Leakage	Pres.: P _s = P _p = 14 MPa Max. Leakage Viscosity: 32 mm ² /s	L/min	0.8 or less	1.2 or less	1.2 or less		
Main Valve Max. Leakage			0.7 or less	1.1 or less	1.2 or less		
Hysteresis		%	0.1 or less				
Step Response (0 <=> 100 %) P _p = 14 MPa (Typical) ⁽⁵⁾		ms	7 (9)	11 (13)	11 (13)	15 (18)	
Frequency Response (±25 % Amplitude) P _p = 14 MPa (Typical) ⁽⁵⁾		Hz	Gain = -3 dB: 125 (110) Phase = -90° : 110 (100)	Gain = -3 dB: 100 (90) Phase = -90° : 90 (90)	Gain = -3 dB: 100 (90) Phase = -90° : 90 (90)	Gain = -3 dB: 75 (70) Phase = -90° : 70 (75)	
Vibration Proof		m/s ²	100				
Protection			IP 65				
Ambient Temperature		°C	0 - +50				
Spool Stroke to Stops		mm	±3.5	±5	±5	±7	
Spool End Area		cm ²	3	7	8	8	
Polarity			See the description about I/O signal characteristics on page I-36.				
Linear Motor Specification	Current	A	Max. 2.1				
	Coil Resistance	Ω	9.6 [at 20 °C]				
Approx. Mass ⁽⁶⁾		kg	8.5 [11]	14 [16]	20 [24]		
Electric Connection			6 + PE/11 + PE Connector 【EN175201 Part 804】				

Note) (1) Pressure at the return port should be at actual supply pressure or less (to use an external pilot type valve with the size “03” at 21 MPa or more, pressures at the T and Y ports should be 7 MPa or less).

(2) Back pressure at the drain port should be 0.05 MPa or less and not be a negative pressure.

(3) Supply pressure for the pilot valve should be 1.5 - 21 MPa and should also be 60 % of actual supply pressure or more.

(4) The pilot flow is calculated based on a pilot pressure of 14 MPa and the above step response.

(5) This value is measured for each valve based on a pilot pressure of 14 MPa; it may vary depending on the actual circuit/operation conditions.

(6) A value in brackets indicates the mass of each valve with a fail-safe solenoid operated valve.

(7) For the effective range of the fail-safe function, see page I-60.

Specifications

LSVHG- *EH- * -4J- * -D * /E * /F *

The values in parentheses in the specification table below are applicable to the models “LSVHG- *EH- * - * - *EH- W * -” (without DR port).

Model Numbers		LSVHG-03EH-210 -4J- * -D * /E * /F *	LSVHG-04EH-580 -4J- * -D * /E * /F *	LSVHG-06EH-820 -4J- * -D * /E * /F *	LSVHG-06EH-1300 -4J- * -D * /E * /F *		
Descriptions							
Spool Type		4J: Open Center A, B & T P→A Flow: 10 % Overlap, B→T Flow: 50 % Underlap P→B Flow: 60 % Overlap, A→T Flow: 5 % Underlap					
Rated Flow (±10%)	ΔP = 3.5 MPa (per Land)	L/min	P→A Flow: 210 B→T Flow: 235 P→B Flow: 95 A→T Flow: 240	P→A Flow: 580 B→T Flow: 675 P→B Flow: 255 A→T Flow: 660	P→A Flow: 820 B→T Flow: 950 P→B Flow: 370 A→T Flow: 940	P→A Flow: 1300 B→T Flow: 1440 P→B Flow: 660 A→T Flow: 1375	
	ΔP = 0.5 MPa (per Land)	L/min	P→A Flow: 79 B→T Flow: 89 P→B Flow: 36 A→T Flow: 91	P→A Flow: 219 B→T Flow: 255 P→B Flow: 96 A→T Flow: 249	P→A Flow: 310 B→T Flow: 359 P→B Flow: 140 A→T Flow: 355	P→A Flow: 491 B→T Flow: 544 P→B Flow: 249 A→T Flow: 520	
Max. Operating Pressure		MPa	31.5	35	35	31.5	
Proof Pres. at Return Port (1)	External Drain	T Port	MPa	21	31.5	35	25
		Y Port	MPa	21 (7)			
	Internal Drain	T & Y Ports	MPa	21 (7)			
DR Port Permissible Back Pressure (2)		MPa	0.05 or less (The valves with the model number “W” have no DR port.)				
Pilot Pressure (3)		MPa	1.5 - 21				
Pilot Flow Rate (4)		L/min	9 (8) or more	20 (17) or more	22 (19) or more	23 (19) or more	
Pilot Valve Max. Leakage	Pres.: PS = PP = 14 MPa Max. Leakage Viscosity: 32 mm ² /s	L/min	0.8 or less	1.2 or less	1.2 or less		
			0.7 or less	1.1 or less	1.2 or less		
Hysteresis		%	0.1 or less				
Step Response (0 <=> 100 %) Pp = 14 MPa (Typical) (5)		ms	7 (9)	11 (13)	11 (13)	15 (18)	
Frequency Response (± 25 % Amplitude) Pp = 14 MPa (Typical) (5)		Hz	Gain = -3 dB: 125 (110) Phase = -90° : 110 (100)	Gain = -3 dB: 100 (90) Phase = -90° : 90 (90)	Gain = -3 dB: 100 (90) Phase = -90° : 90 (90)	Gain = -3 dB: 75 (70) Phase = -90° : 70 (75)	
Vibration Proof		m/s ²	100				
Protection			IP 65				
Ambient Temperature		°C	0 - +50				
Spool Stroke to Stops		mm	±3.5	±5	±5	±7	
Spool End Area		cm ²	3	7	8	8	
Polarity			See the description about I/O signal characteristics on page I-36.				
Linear Motor Specification	Current	A	Max. 2.1				
	Coil Resistance	Ω	9.6 [at 20 °C]				
Approx. Mass (6)		kg	8.5 [11]	14 [16]	20 [24]		
Electric Connection			6 + PE/11 + PE Connector [EN175201 Part 804]				

- Note) (1) Pressure at the return port should be at actual supply pressure or less (to use an external pilot type valve with the size “03” at 21 MPa or more, pressures at the T and Y ports should be 7 MPa or less).
 (2) Back pressure at the drain port should be 0.05 MPa or less and not be a negative pressure.
 (3) Supply pressure for the pilot valve should be 1.5 - 21 MPa and should also be 60 % of actual supply pressure or more.
 (4) The pilot flow is calculated based on a pilot pressure of 14 MPa and the above step response.
 (5) This value is measured for each valve based on a pilot pressure of 14 MPa; it may vary depending on the actual circuit/operation conditions.
 (6) A value in brackets indicates the mass of each valve with a fail-safe solenoid operated valve.
 (7) For the effective range of the fail-safe function, see page I-60.

Accessories

Mounting Bolts

Model Numbers	Mounting Bolt	Qty.	Bolt Tightening Torque
LSVHG-03EH	Hex. Soc. Head Cap Screw : M6×35L	4	12.9 - 15.9 Nm
LSVHG-04EH	Hex. Soc. Head Cap Screw : M6×55L	2	12.9 - 15.9 Nm
	Hex. Soc. Head Cap Screw : M10×60L	4	60.6 - 74.1 Nm
LSVHG-06EH	Hex. Soc. Head Cap Screw : M12×85L	6	104 - 127 Nm
LSVHG-10EH	Hex. Soc. Head Cap Screw : M20×90L	6	493 - 603 Nm

Connector

Model Numbers	Connector	Qty.	Remarks
LSVHG- *EH - * - * 1	6 + PE Electrical Plug	1	Compatible with EN 175201 PART 804
LSVHG- *EH - * - * 2	11 + PE Electrical Plug	1	

Electrical Specifications

6 + PE Connector

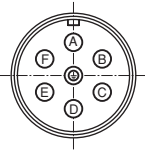

Pin		Valve Model		
		LSVHG- *EH- * -A1 LSVHG- *EH- * -D1	LSVHG- *EH- * -B1 LSVHG- *EH- * -E1	LSVHG- *EH- * -C1 LSVHG- *EH- * -F1
Pin A	Power Supply	24 V DC (21.6 - 26.4 V DC Included Ripple), 50 VA or more		
Pin B		0 V		
Pin C	Signal Common	COM (0 V)		
Pin D	Input (+) (Differential) ^{★1}	0 - ±10 V	4 - 20 mA	0 - ±10 mA
Pin E	Input (-) (Differential) ^{★1}	R _i = 100 kΩ	R _i = 200 Ω	R _i = 200 Ω
Pin F	Spool Travel Monitoring	0 - ±10 V R _L ≥ 10 kΩ	4 - 20 mA R _L = 100 - 500 Ω ^{★2}	0 - ±10 mA R _L = 100 - 500 Ω ^{★2}
Pin	Protective Earth	—		

11 + PE Connector

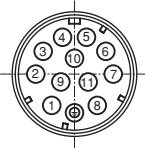

Pin		Valve Model		
		LSVHG- *EH- * -A2 LSVHG- *EH- * -D2	LSVHG- *EH- * -B2 LSVHG- *EH- * -E2	LSVHG- *EH- * -C2 LSVHG- *EH- * -F2
Pin 1	Power Supply	24 V DC (21.6 - 26.4 V DC Included Ripple), 50 VA or more		
Pin 2		0 V		
Pin 3	Enable (Servo ON) Input	Input Current = 3 - 5 mA at 4.8 - 28 V DC		
Pin 4	Input (+) (Differential) ^{★1}	0 - ±10 V	4 - 20 mA	0 - ±10 mA
Pin 5	Input (-) (Differential) ^{★1}	R _i = 100 kΩ	R _i = 200 Ω	R _i = 200 Ω
Pin 6	Spool Travel Monitoring	0 - ±10 V R _L ≥ 10 kΩ	4 - 20 mA R _L = 100 - 500 Ω ^{★2}	0 - ±10 mA R _L = 100 - 500 Ω ^{★2}
Pin 7	Signal Common	COM (0 V)		
Pin 8	Valve Ready Output	Open Collector Output Voltage: Max. 30 V, Current: Max. 20 mA		
Pin 9 ^{★3}	Power Supply (For Solenoid Operated Valve)	24 V DC (21.6 - 26.4 V DC Included Ripple), 14 VA (Holding Current: 0.6 A)		
Pin 10 ^{★3}		0 V		
Pin 11	Alarm Output	Open Collector Output Voltage: Max. 30 V, Current: Max. 20 mA		
Pin	Protective Earth	—		

★1. Differential input signals can be used only for the valves with the voltage signal specifications of ±10 V (LSVHG- *EH-A*/D*).

★2. The recommended load resistance is 200 Ω.

★3. Pins 9 and 10 are used only for the valves with a fail-safe solenoid operated valve. In this case, use a separate power source for the solenoid operated valve from the power source for the amplifier (Pins 1 and 2).

I/O Signal Characteristics

· LSVHG- *EH- * -A*/B*/C*

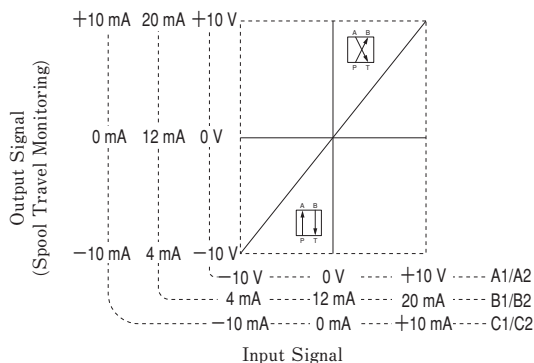

· LSVHG- *EH- * -D*/E*/F*

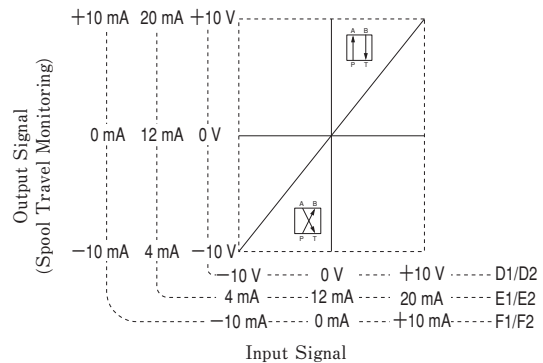

Block Diagram

● LSVHG- *EH- * - * -A1/D1 (6 + PE Connector)

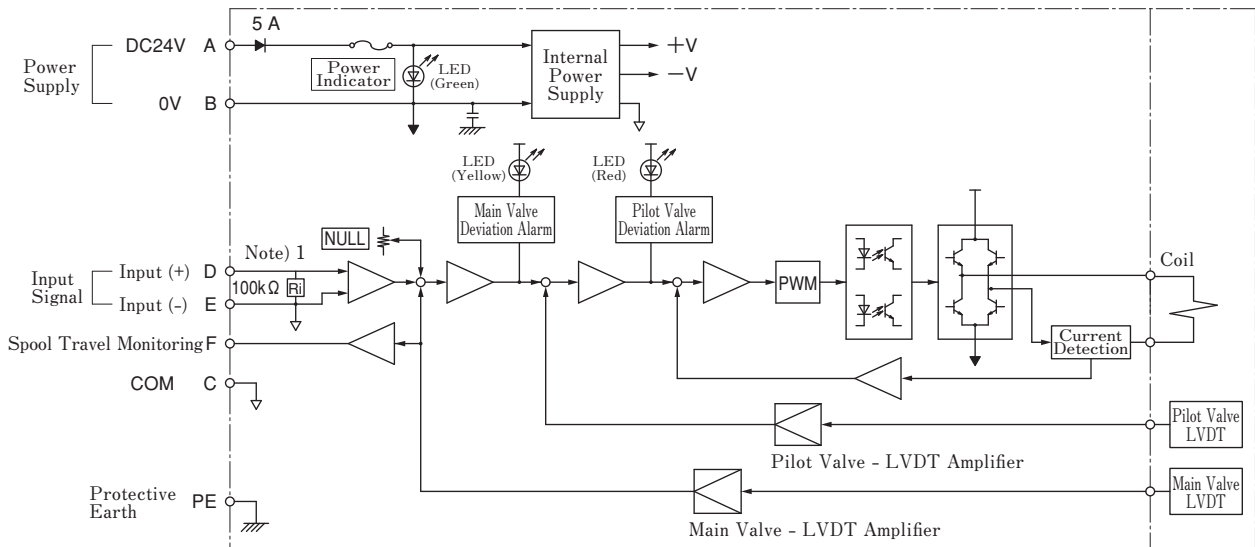

Note) 1. The input stage for the models LSVHS- *EH- * - * -B1/C1/E1/F1 (current signal) is as follows.

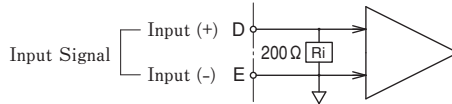

● LSVHG- *EH- * - * -A2/D2 (11 + PE Connector)

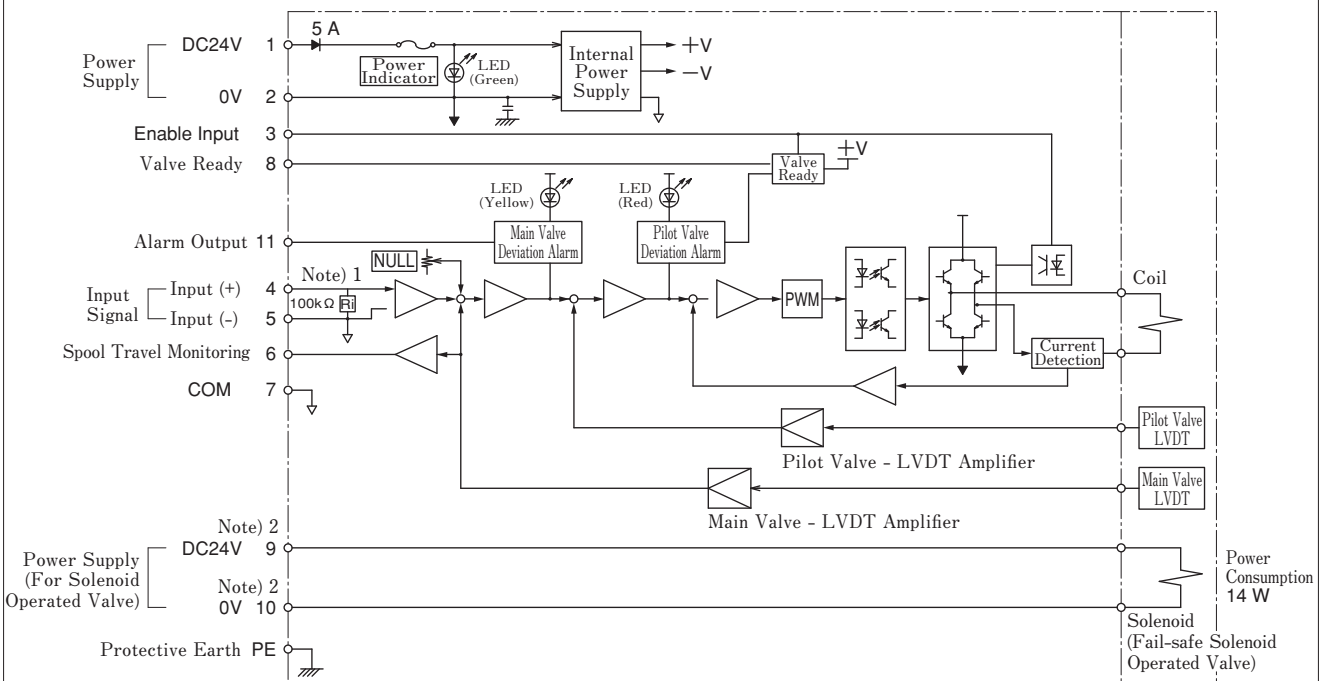

Note) 1. The input stage for the models LSVHG- *EH- * - * -B2/C2/E2/F2 (current signal) is as follows.

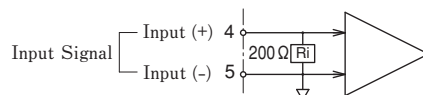

2. Pins 9 and 10 are used only for the models LSVHG- *EH- * - * - *E* with a fail-safe solenoid operated valve.

LSVHG-03EH-230/270

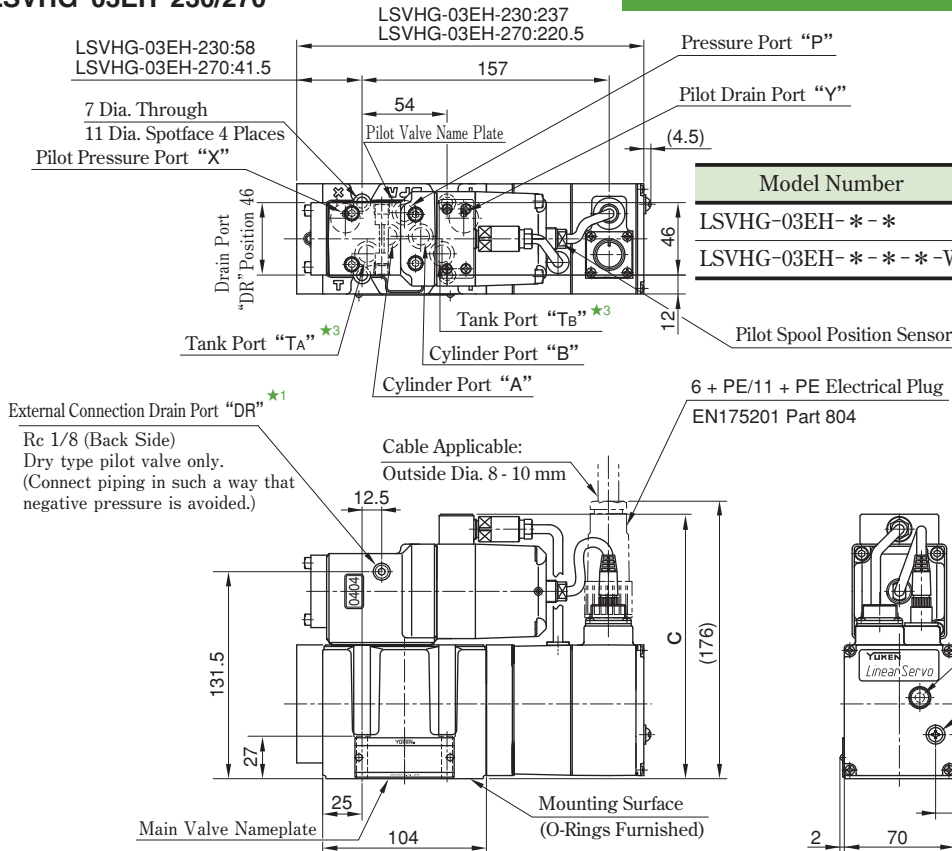

Model Number	C	Remarks
LSVHG-03EH- * - *	168	Pilot Valve: Dry Type
LSVHG-03EH- * - * - W	177	Pilot Valve: Wet Type

- ★1. The external connection drain port "DR" on the front side is usually plugged. To use the port on the front side, remove the hexagon socket head plug (5 Hex.) and plug the port on the back side.
- ★2. To adjust the null, remove the protective screw and turn the null trimmer. After adjustment, be sure to attach the protective screw.

LSVHG-03EH-230/270- * - * EA/EB/EC (With Fail-safe Solenoid Operated Valve)

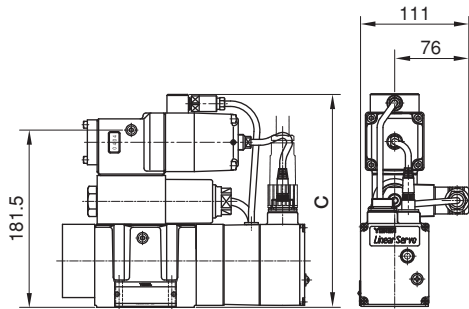

Detailed Graphic Symbol

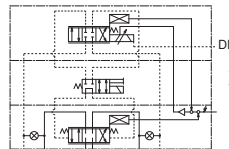

Note) The configuration in the shaded area varies with the selected spool type (corresponding to Graphic Symbols on page I-31).

⊗ : Plugs for selecting the pilot and drain types

[Dimensions of Mounting Surface]

Prepare a mounting surface shown below. Basically, the dimensions of the mounting surface conform to ISO 4401-05-05-0-05. The mounting surface should have a good machined finish. (1/6)

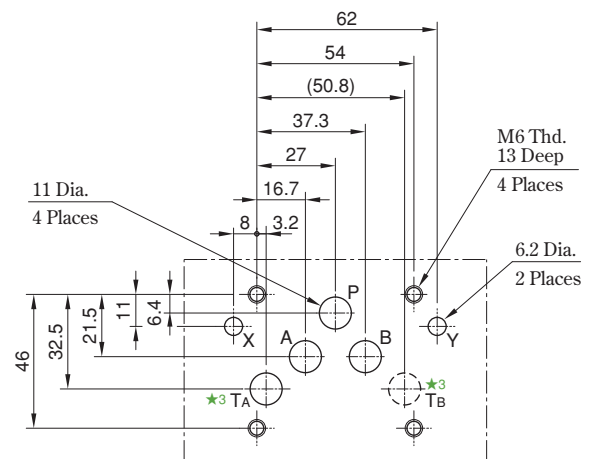

★3. There are two tank ports "TA" and "TB"; however, "TA" may be used alone.

Model Numbers	C	Remarks
LSVHG-03EH- * - * - E *	218	Pilot Valve: Dry Type
LSVHG-03EH- * - * - WE *	227	Pilot Valve: Wet Type

● For other dimensions, see the figures above (the models without a fail-safe solenoid operated valve).

● O-Rings for the Ports

Port	O-Ring Size	Qty.
P, A, B, T	AS568-014 (NBR-90)	5
X, Y	AS568-016 (NBR-90)	2

O-Rings made of fluorinated rubber are required to use phosphate ester type fluids.

LSVHG-04EH-750

Model Numbers	C	Remarks
LSVHG-04EH-750-*	194	Pilot Valve: Dry Type
LSVHG-04EH-750-*-W	203	Pilot Valve: Wet Type

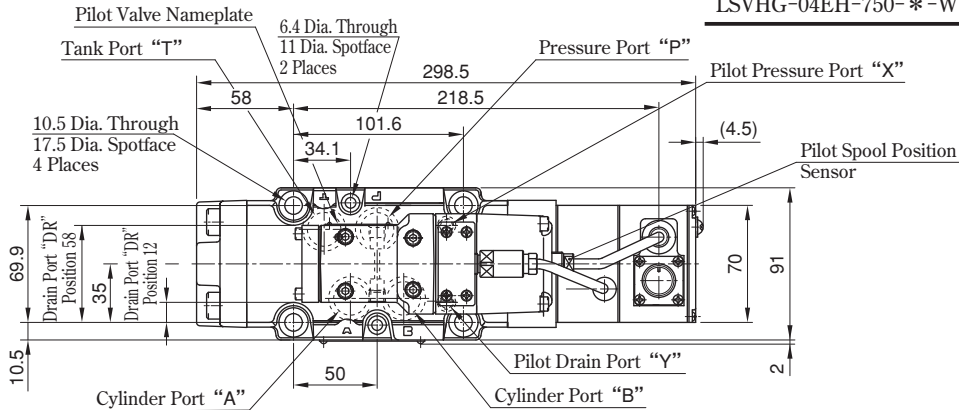

★1
External Connection Drain Port "DR"
Rc 1/8 (Back Side)
Dry type pilot valve only.
(Connect piping in such a way that
negative pressure is avoided.)

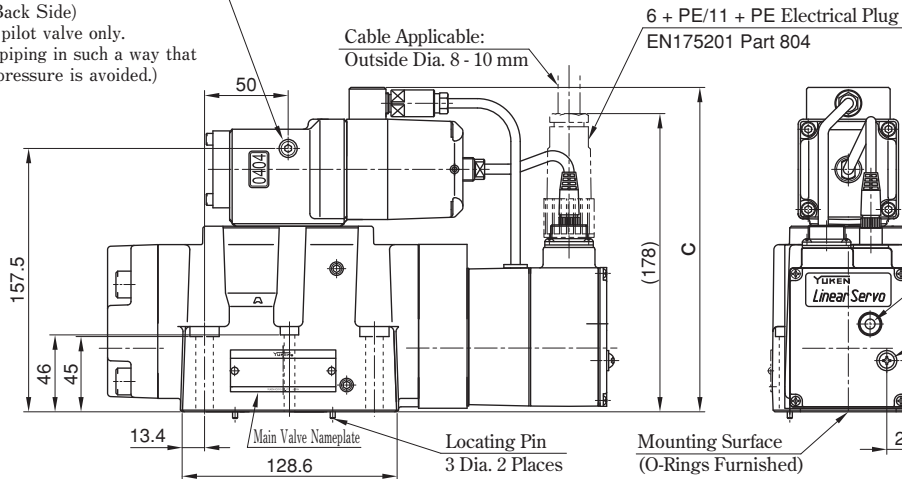

Color	Indicator Lamp
Green	Power Supply
Red	Pilot Valve Deviation Alarm
Yellow	Main Valve Deviation Alarm

- ★1. The external connection drain port "DR" on the front side is usually plugged. To use the port on the front side, remove the hexagon socket head plug (5 Hex.) and plug the port on the back side.
- ★2. To adjust the null, remove the protective screw and turn the null trimmer. After adjustment, be sure to attach the protective screw.

LSVHG-04EH-750- *- * EA/EB/EC (With Fail-safe Solenoid Operated Valve)

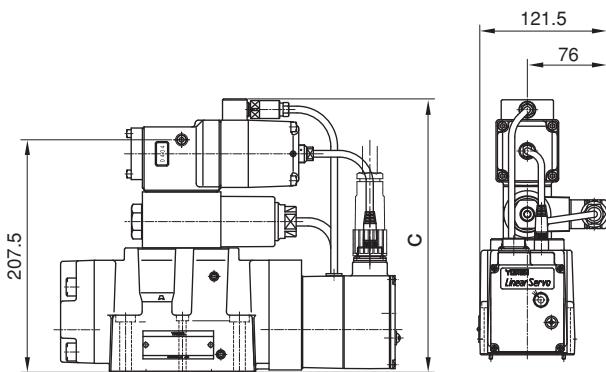

Detailed Graphic Symbol

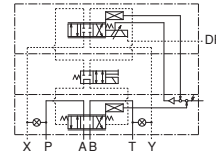

Note) The configuration in the shaded area varies with the selected spool type (corresponding to Graphic Symbols on page I-31).

Model Numbers	C	Remarks
LSVHG-04EH-750- *- * -E *	244	Pilot Valve: Dry Type
LSVHG-04EH-750- *- * -WE *	253	Pilot Valve: Wet Type

● For other dimensions, see the figures above (the models without a fail-safe solenoid operated valve).

● O-Rings for the Ports

Port	O-Ring Size	Qty.
P, A, B, T	OR NBR-90 P22-N	4
X, Y	AS568-012 (NBR-90)	2

O-Rings made of fluorinated rubber are required to use phosphate ester type fluids.

【Dimensions of Mounting Surface】

The dimensions of the mounting surface are the same as those of the models LSVHG-04 (page I-12).

LSVHG-06EH-900/1300

Model Numbers	C	Remarks
LSVHG-06EH- * - *	244	Pilot Valve: Dry Type
LSVHG-06EH- * - * -W	253	Pilot Valve: Wet Type

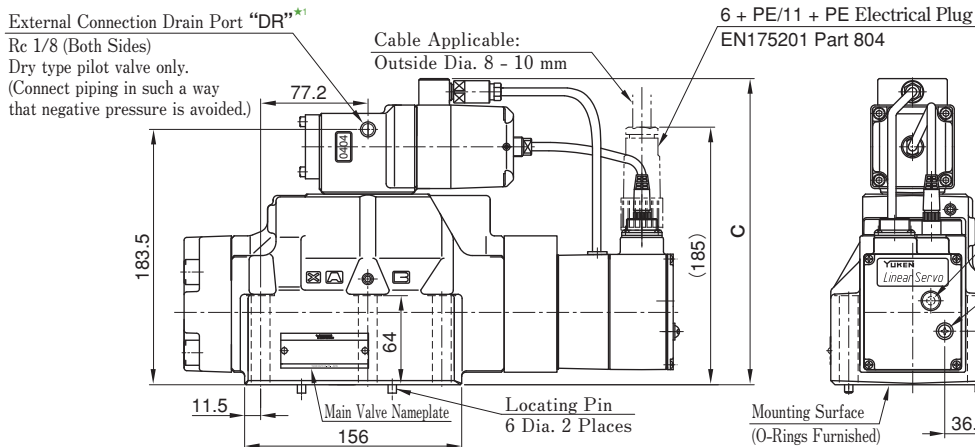
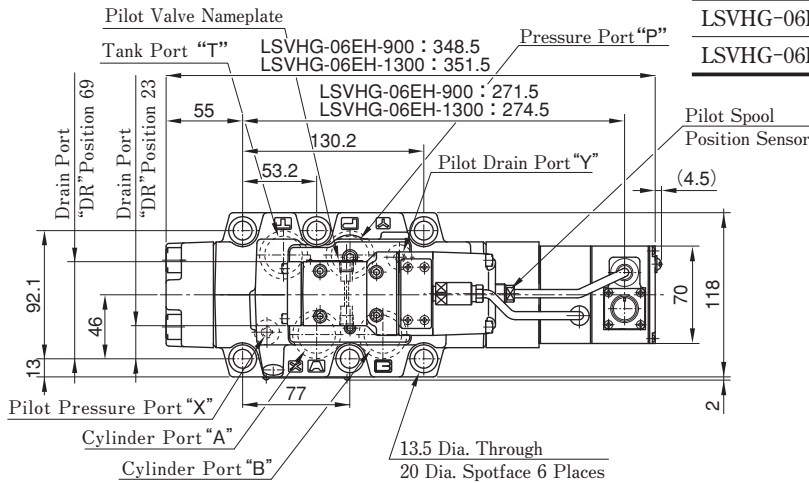

Color	Indicator Lamp
Green	Power Supply
Red	Pilot Valve Deviation Alarm
Yellow	Main Valve Deviation Alarm

- ★1. The external connection drain port "DR" on the back side is usually plugged. To use the port on the back side, remove the hexagon socket head plug (Hex. 5) and plug the port on the front side.
- ★2. To adjust the null, remove the protective screw and turn the null trimmer. After adjustment, be sure to attach the protective screw.

LSVHG-06EH-900/1300- * - * EA/EB/EC (With Fail-safe Solenoid Operated Valve)

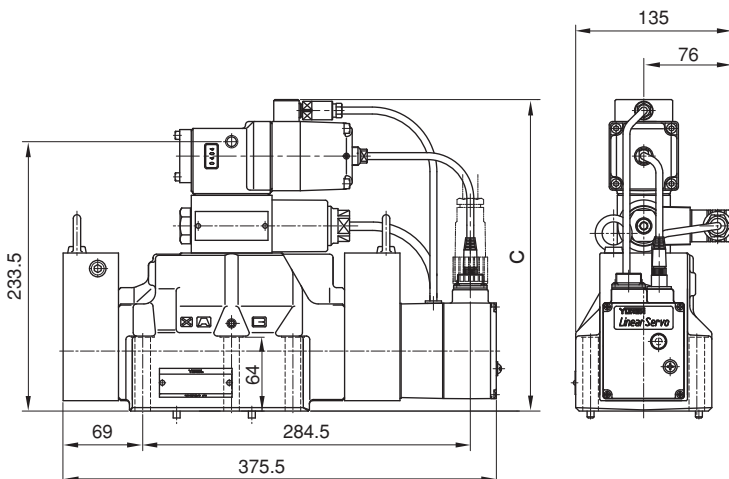

Detailed Graphic Symbol

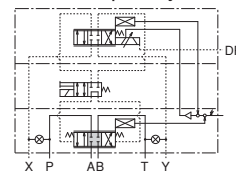

Note) The configuration in the shaded area varies with the selected spool type (corresponding to Graphic Symbols on page I-31).

Model Numbers	C	Remarks
LSVHG-06EH- * - * -E *	270	Pilot Valve: Dry Type
LSVHG-06EH- * - * -WE *	279	Pilot Valve: Wet Type

● For other dimensions, see the figures above (the models without a fail-safe solenoid operated valve).

● O-Rings for the Ports

Port	O-Ring Size		Qty.
	LSVHG-06EH-900	LSVHG-06EH-1300	
P, A, B, T	AS568-123 (NBR-90)	AS568-126 (NBR-90)	4
X, Y	OR NBR-90 P14-N		2

O-Rings made of fluorinated rubber are required to use phosphate ester type fluids.

[Dimensions of Mounting Surface]

The dimensions of the mounting surface are the same as those of the models LSVHG-06 (page I-13).

LSVHG-10EH-3800

Model Numbers	C	Remarks
LSVHG-10EH-**-*	343	Pilot Valve: Dry Type
LSVHG-10EH-***-W	352	Pilot Valve: Wet Type

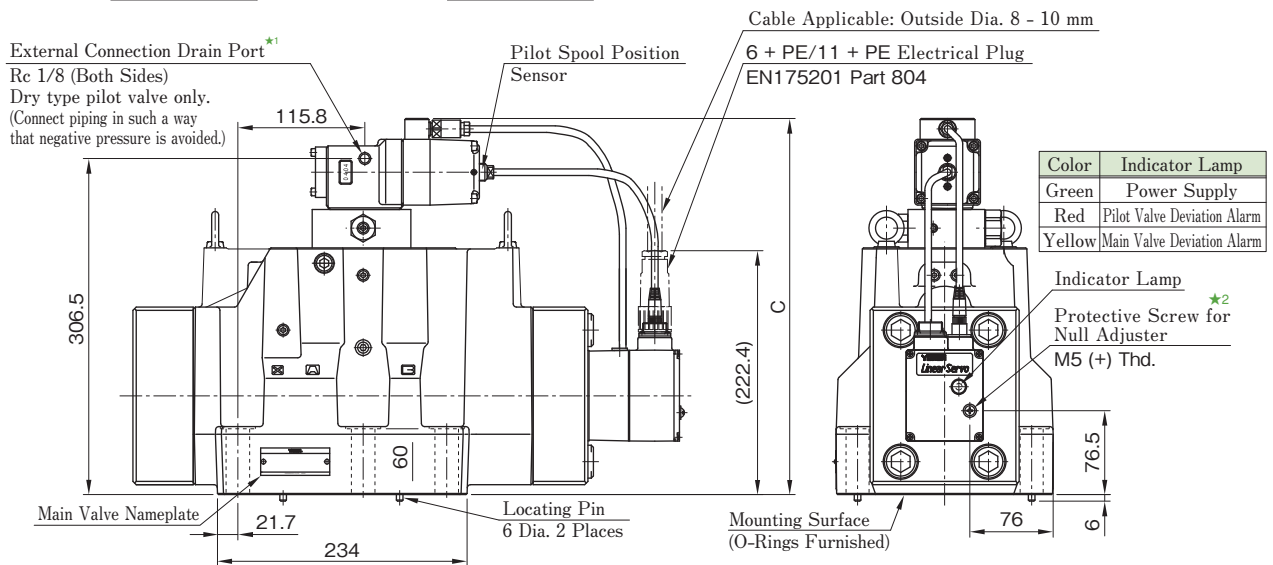
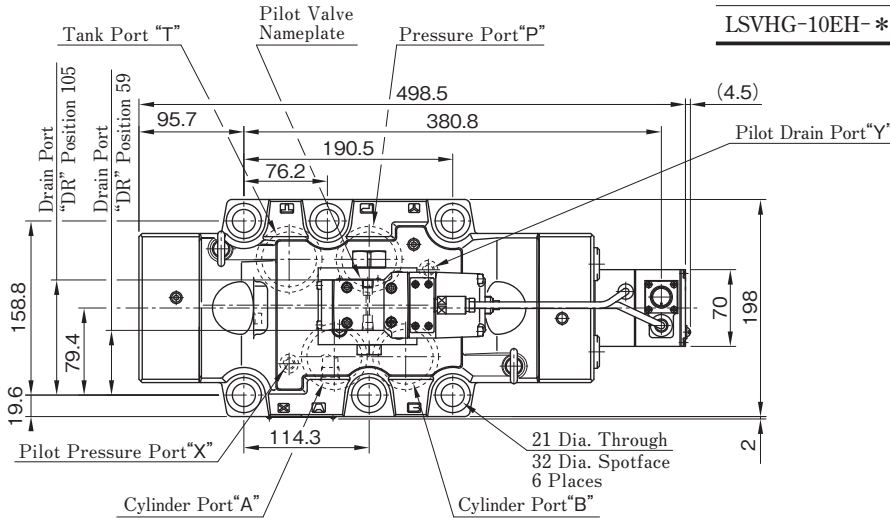

- ★1. The external connection drain port "DR" on the back side is usually plugged. To use the port on the back side, remove the hexagon socket head plug (Hex. 5) and plug the port on the front side.
- ★2. To adjust the null, remove the protective screw and turn the null trimmer. After adjustment, be sure to attach the protective screw.

[Dimensions of Mounting Surface]

The dimension of the mounting surface can be fitted with ISO standard. However, the hole dia. of P,A,B,T are different with those. Please see mounting surface as shown right.

	ISO 4401-10-08-0-94	Mounting Surface for LSVHG-10EH
Hole dia. Of P,A,B,T port.	36 Dia.	50 Dia.

The mounting surface should have a good machined finish. ($\sqrt{16}$)

● O-Rings for the Ports

Port	O-Ring Size	Qty.
P, A, B, T	AS568-227 (NBR-90)	4
X, Y	AS568-015 (NBR-90)	2

O-Rings made of fluorinated rubber are required to use phosphate ester type fluids.

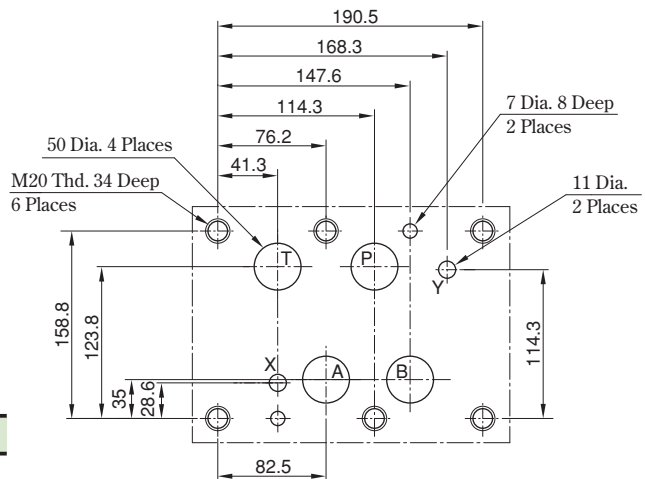

Characteristics of LSVHG-03EH-230 (Fluid Viscosity: 30 mm²/s)

No-Load Flow Characteristics

<Conditions> ● Valve Pressure Difference: 1 MPa (Pressure Difference per Land: 0.5 MPa)
 Around Null Position Input Signal -20 ⇔ +20 %

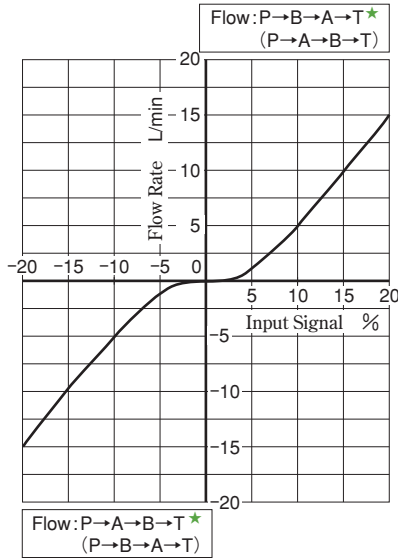
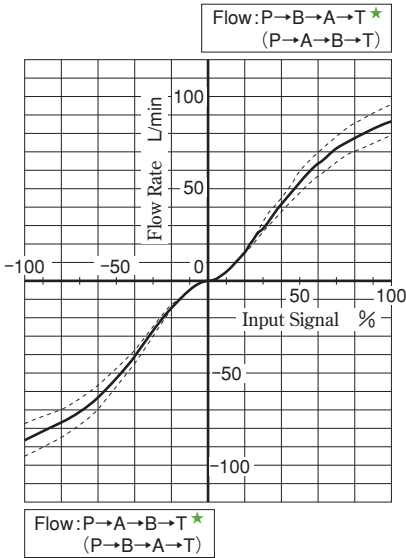

Load Flow Characteristics

<Conditions>
 ● Input Signal : 100 %
 Note) Tolerance for Load Flow : ±10 %

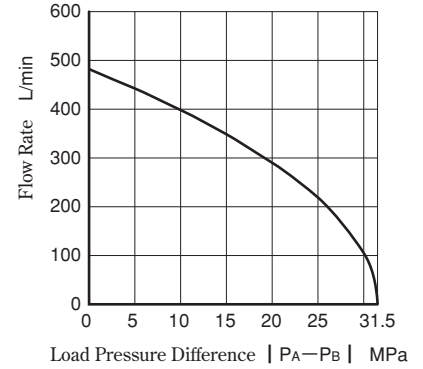

★ The flow outside of parentheses is achieved when the input signal type "A", "B", or "C" is selected. The flow in parentheses is achieved when "D", "E", or "F" is selected.

Step Response

<Conditions> ● Input Signal : 0 ⇔ 100 % ● Supply/Pilot Pressure : 14 MPa

Pilot Valve: Dry Type

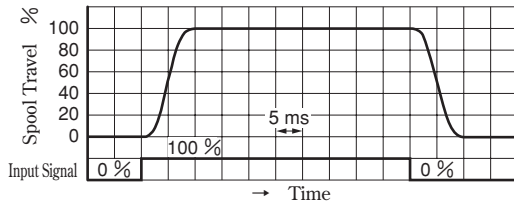

Pilot Valve: Wet Type

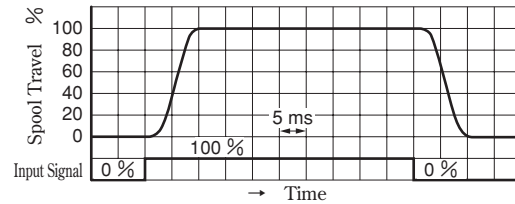

Frequency Response

<Conditions> ● Hydraulic Circuit: Port A/B Closed ● Supply/Pilot Pressure : 14 MPa

Pilot Valve: Dry Type

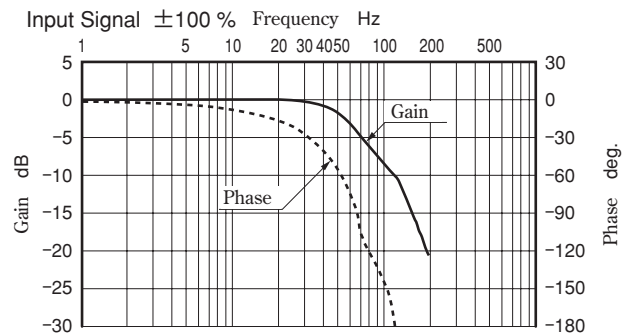
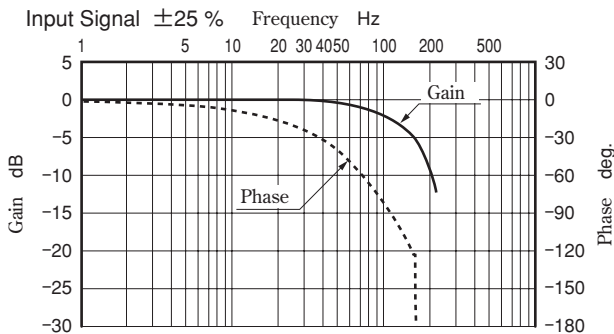

Pilot Valve: Wet Type

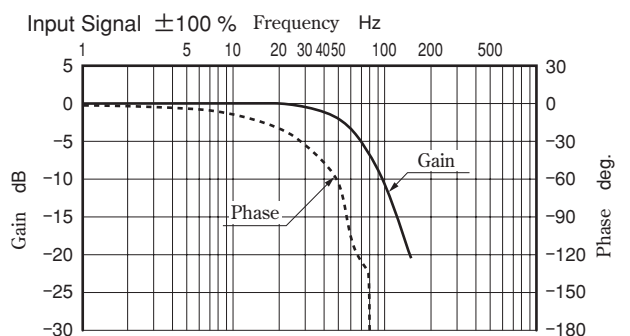
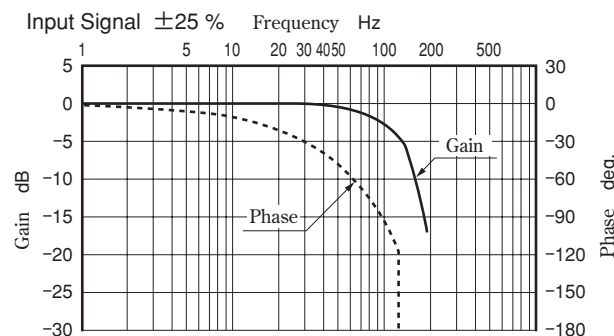

Characteristics of LSVHG-03EH-270-2/40/2P (Fluid Viscosity: 30 mm²/s)

No-Load Flow Characteristics

<Conditions> ● Valve Pressure Difference: 1 MPa (Pressure Difference per Land: 0.5 MPa)

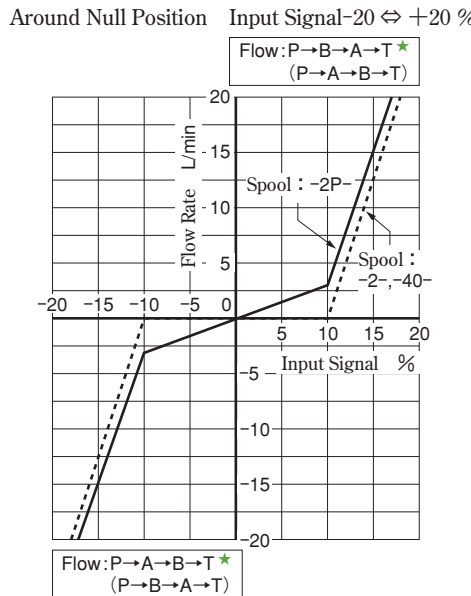
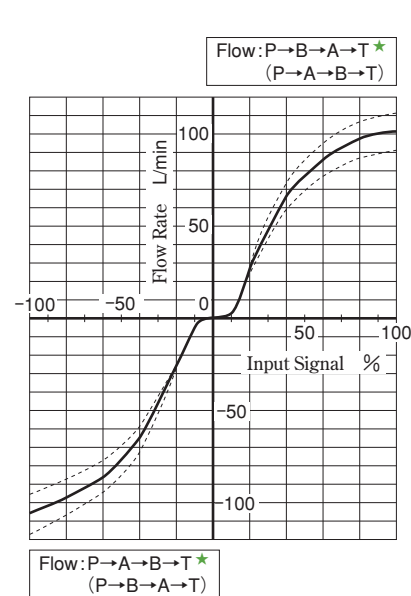

Load Flow Characteristics

<Conditions>

● Input Signal : 100 %

Note) Tolerance for Load Flow : ±10 %

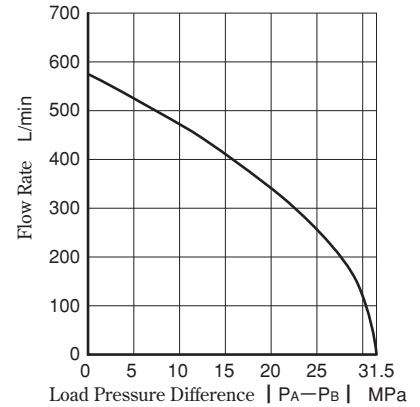

★ The flow outside of parentheses is achieved when the input signal type "A", "B", or "C" is selected. The flow in parentheses is achieved when "D", "E", or "F" is selected.

Step Response

<Conditions> ● Input Signal : 0 ↔ 100 % ● Supply/Pilot Pressure : 14 MPa

● Pilot Valve: Dry Type

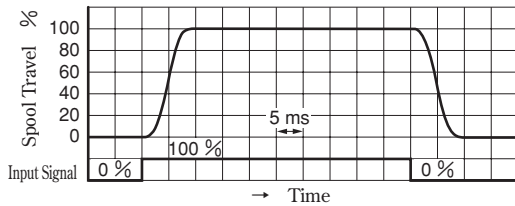

● Pilot Valve: Wet Type

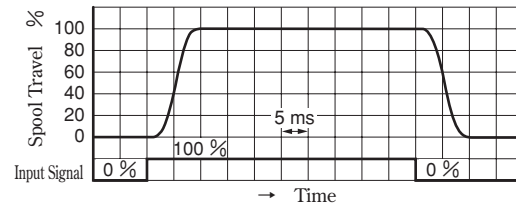

Frequency Response

<Conditions> ● Hydraulic Circuit: Port A/B Closed ● Supply/Pilot Pressure : 14 MPa

● Pilot Valve: Dry Type

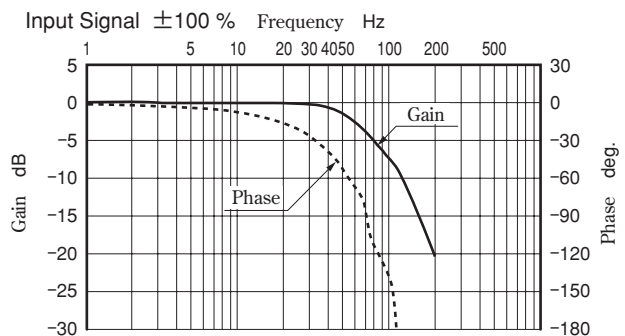
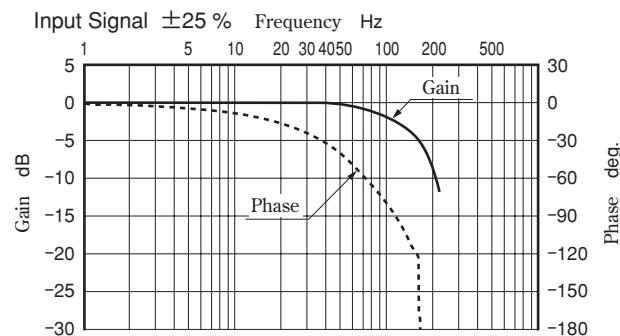

● Pilot Valve: Wet Type

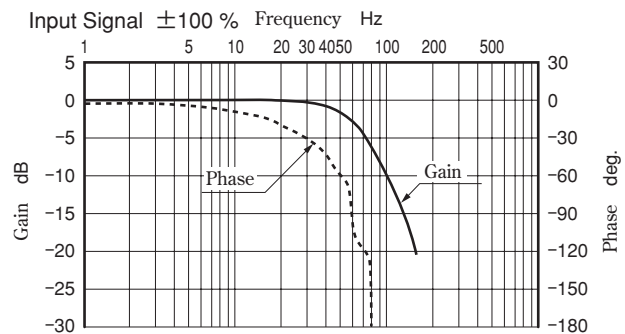
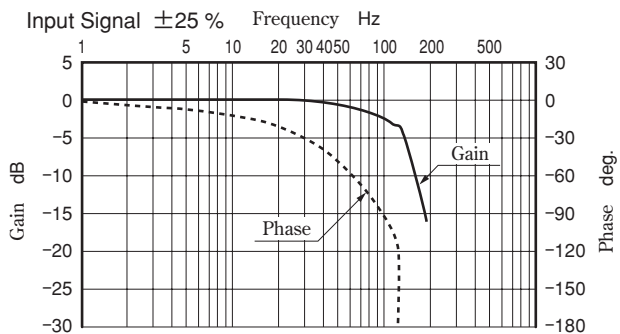

Characteristics of LSVHG-03EH-210-4J (Fluid Viscosity: 30 mm²/s)

No-Load Flow Characteristics

<Conditions> ● Valve Pressure Difference: $\Delta P = 0.5 \text{ MPa}$ (per Land)

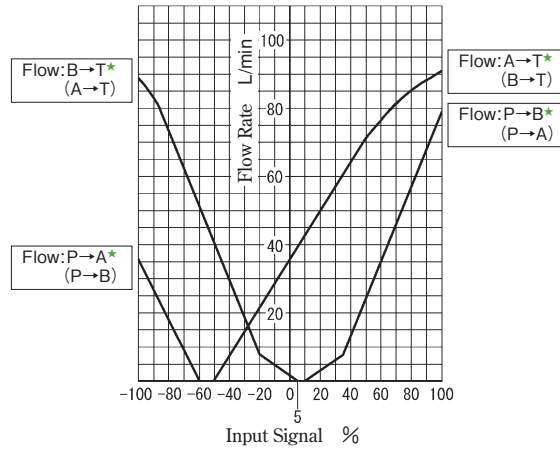

★ The flow outside of parentheses is achieved when the input signal type “A”, “B”, or “C” is selected. The flow in parentheses is achieved when “D”, “E”, or “F” is selected.

Characteristics of LSVHG-04EH-750-2/40/2P (Fluid Viscosity: 30 mm²/s)

No-Load Flow Characteristics

<Conditions> ● Valve Pressure Difference: 1 MPa (Pressure Difference per Land: 0.5 MPa)
 Around Null Position Input Signal -20 ⇔ +20 %

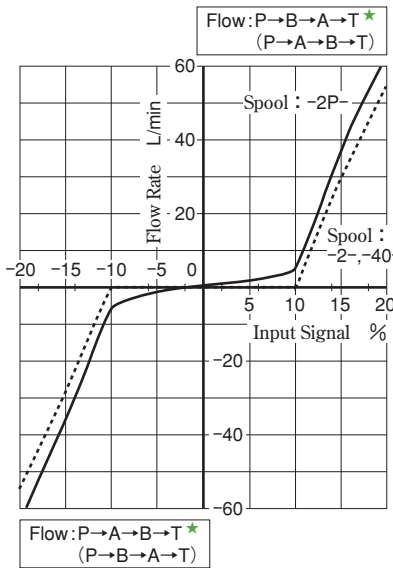
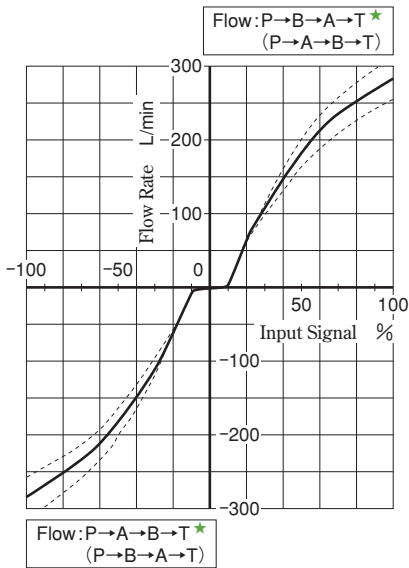

Load Flow Characteristics

<Conditions> ● Input Signal : 100 %
 Note) Tolerance for Load Flow : ±10 %

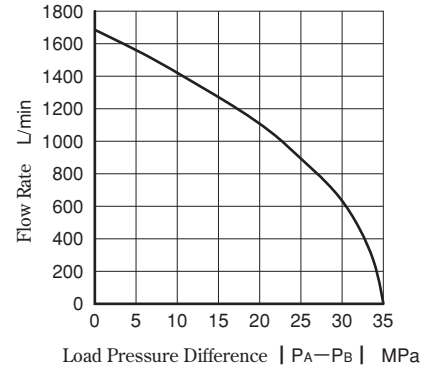

★ The flow outside of parentheses is achieved when the input signal type "A", "B", or "C" is selected. The flow in parentheses is achieved when "D", "E", or "F" is selected.

Step Response

<Conditions> ● Input Signal : 0 ⇔ 100 % ● Supply/Pilot Pressure : 14 MPa

● Pilot Valve: Dry Type

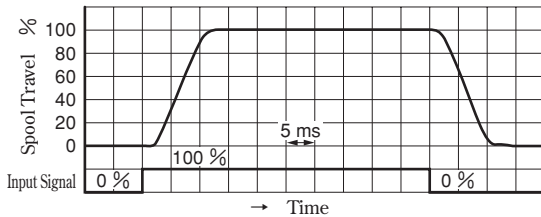

● Pilot Valve: Wet Type

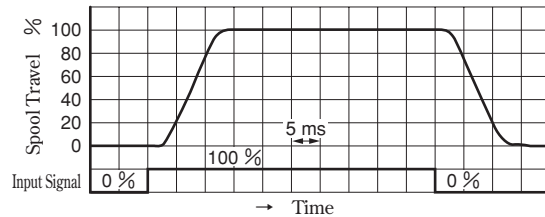

Frequency Response

<Conditions> ● Hydraulic Circuit: Port A/B Closed ● Supply/Pilot Pressure : 14 MPa

● Pilot Valve: Dry Type

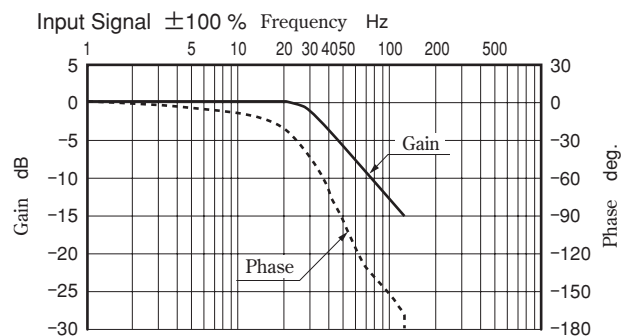
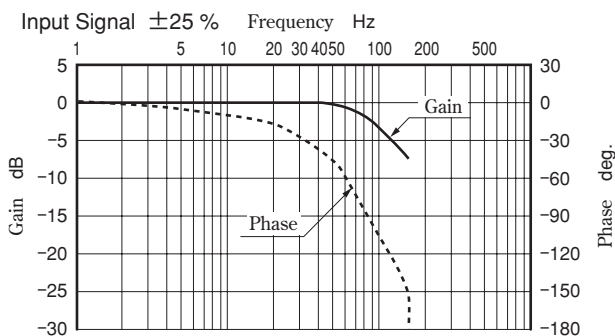

● Pilot Valve: Wet Type

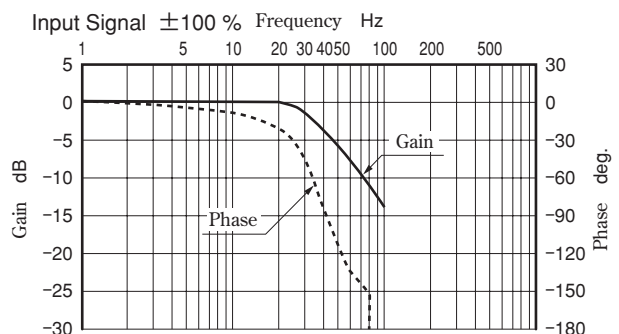
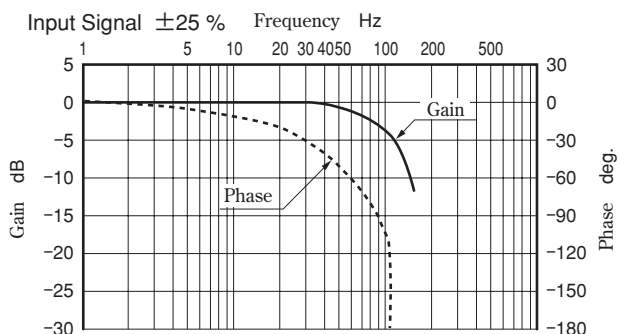

Characteristics of LSVHG-04EH-750-2L (Fluid Viscosity: 30 mm²/s)

No-Load Flow Characteristics

◁Conditions▷ ● Valve Pressure Difference: ΔP = 1 MPa (4-Way Valve) (Pressure Difference per Land: 0.5 MPa)

Around Null Position Input Signal -20 ↔ +20 %

The load flow characteristics, step response, and frequency response are the same as those of the spool types "2", "40", and "2P".

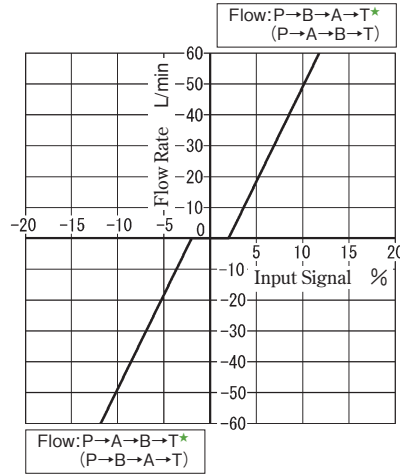
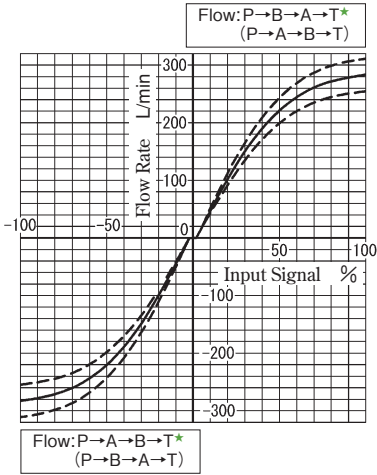

★ The flow outside of parentheses is achieved when the input signal type "A", "B", or "C" is selected. The flow in parentheses is achieved when "D", "E", or "F" is selected.

Characteristics of LSVHG-04EH-580-4J (Fluid Viscosity: 30 mm²/s)

No-Load Flow Characteristics

◁Conditions▷ ● Valve Pressure Difference: ΔP = 0.5 MPa (per Land)

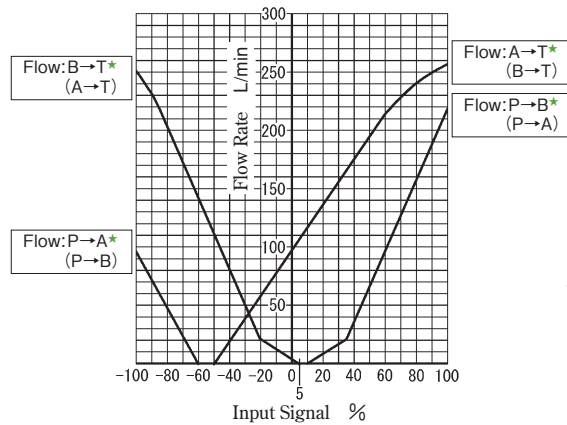

★ The flow outside of parentheses is achieved when the input signal type "A", "B", or "C" is selected. The flow in parentheses is achieved when "D", "E", or "F" is selected.

Characteristics of LSVHG-06EH-900-2/40/2P (Fluid Viscosity: 30 mm²/s)

No-Load Flow Characteristics

<Conditions> ● Valve Pressure Difference: 1 MPa (Pressure Difference per Land: 0.5 MPa)
 Around Null Position Input Signal -20 ⇔ +20 %

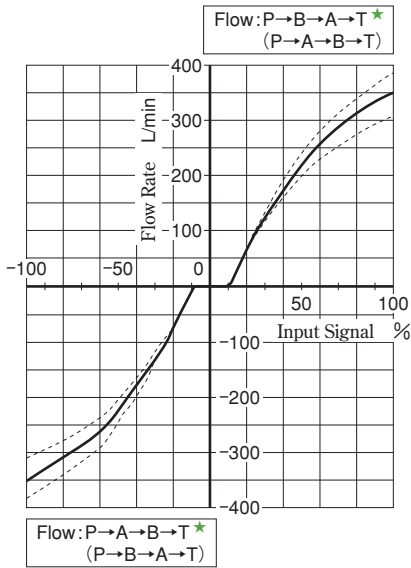

Input Signal -20 ⇔ +20 %

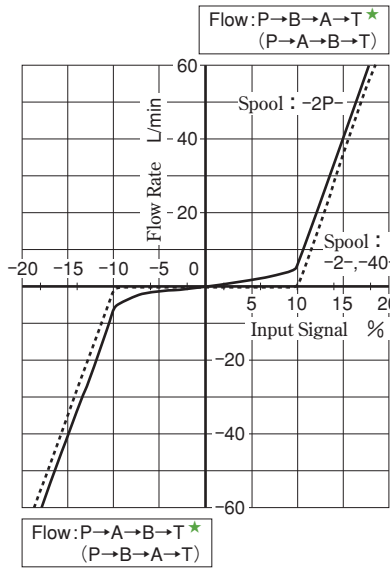

Load Flow Characteristics

<Conditions> ● Input Signal : 100 %
 Note) Tolerance for Load Flow : ±10 %

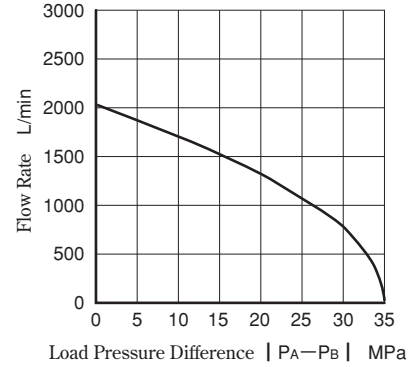

★ The flow outside of parentheses is achieved when the input signal type "A", "B", or "C" is selected. The flow in parentheses is achieved when "D", "E", or "F" is selected.

Step Response

<Conditions> ● Input Signal : 0 ⇔ 100 % ● Supply/Pilot Pressure : 14 MPa

Pilot Valve: Dry Type

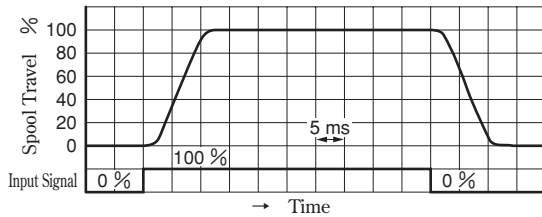

Pilot Valve: Wet Type

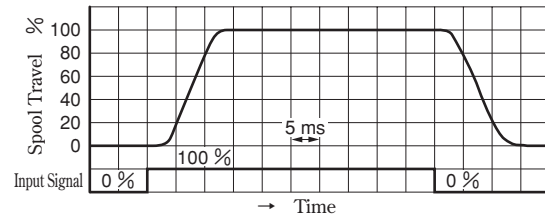

Frequency Response

<Conditions> ● Hydraulic Circuit: Port A/B Closed ● Supply/Pilot Pressure : 14 MPa

Pilot Valve: Dry Type

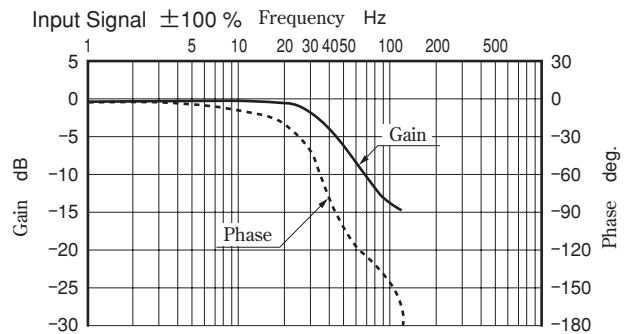
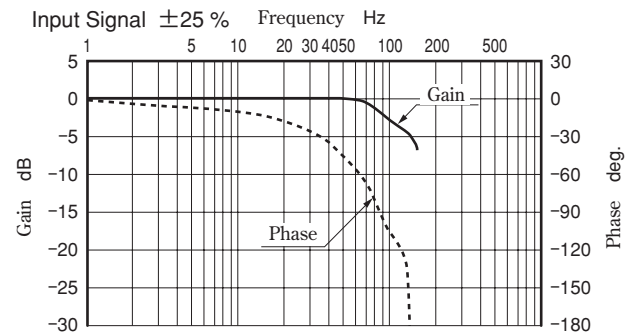

Pilot Valve: Wet Type

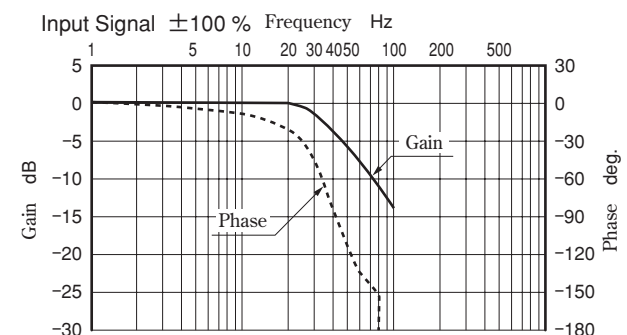
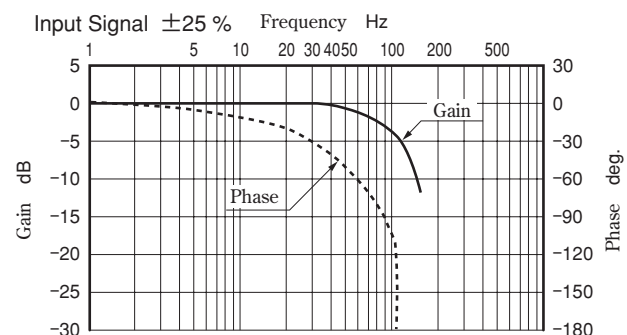

Characteristics of LSVHG-06EH-900-2L (Fluid Viscosity: 30 mm²/s)

No-Load Flow Characteristics <Conditions> ● Valve Pressure Difference: $\Delta P = 1$ MPa (4-Way Valve) (Pressure Difference per Land: 0.5 MPa)

Around Null Position Input Signal -20 \leftrightarrow +20 %

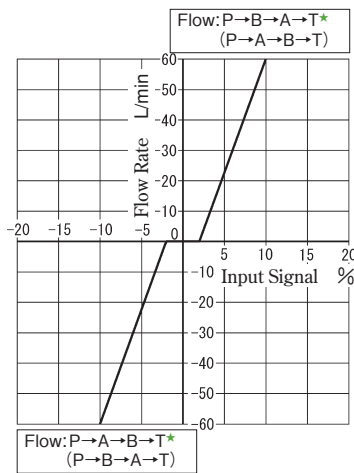
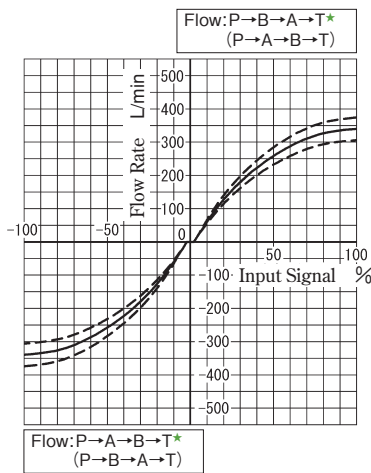

The load flow characteristics, step response, and frequency response are the same as those of the spool types "2", "40", and "2P".

★ The flow outside of parentheses is achieved when the input signal type "A", "B", or "C" is selected. The flow in parentheses is achieved when "D", "E", or "F" is selected.

Characteristics of LSVHG-06EH-1300-2L (Fluid Viscosity: 30 mm²/s)

No-Load Flow Characteristics <Conditions> ● Valve Pressure Difference: $\Delta P = 1$ MPa (4-Way Valve) (Pressure Difference per Land: 0.5 MPa)

Around Null Position Input Signal -20 \leftrightarrow +20 %

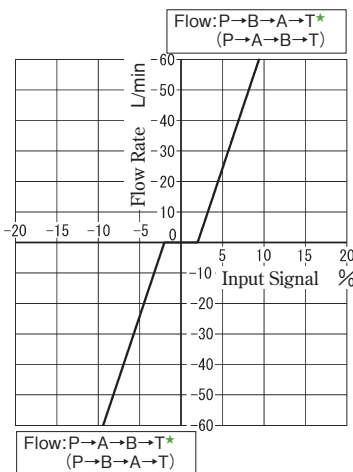
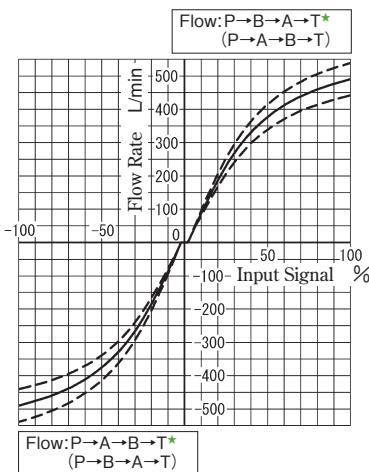

The load flow characteristics, step response, and frequency response are the same as those of the spool types "2", "40", and "2P".

★ The flow outside of parentheses is achieved when the input signal type "A", "B", or "C" is selected. The flow in parentheses is achieved when "D", "E", or "F" is selected.

Characteristics of LSVHG-06EH-820/1300-4J (Fluid Viscosity: 30 mm²/s)

No-Load Flow Characteristics <Conditions> ● Valve Pressure Difference: $\Delta P = 0.5$ MPa (per Land)

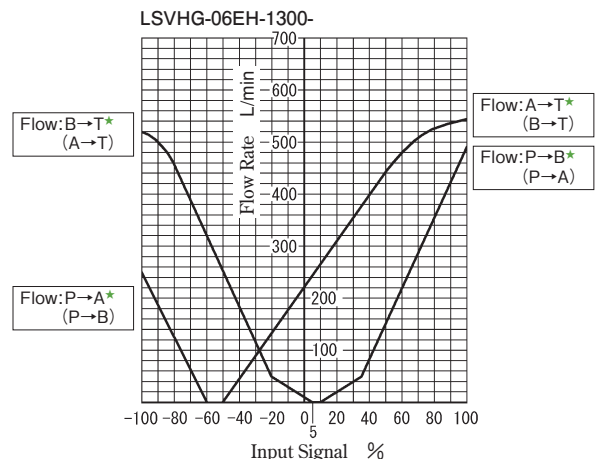
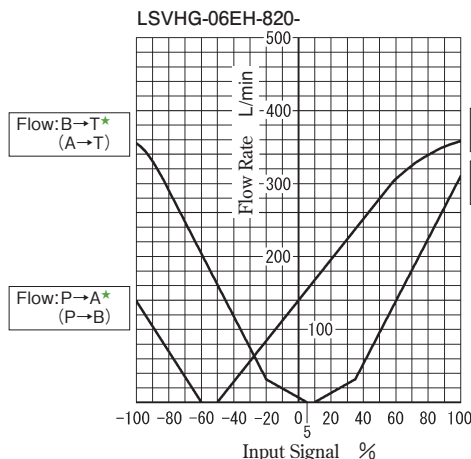

★ The flow outside of parentheses is achieved when the input signal type "A", "B", or "C" is selected. The flow in parentheses is achieved when "D", "E", or "F" is selected.

Characteristics of LSVHG-06EH-1300-2/40/2P (Fluid Viscosity: 30 mm²/s)

No-Load Flow Characteristics

<Conditions> ● Valve Pressure Difference: 1 MPa (Pressure Difference per Land: 0.5 MPa)
 Around Null Position Input Signal -20 ⇔ +20 %

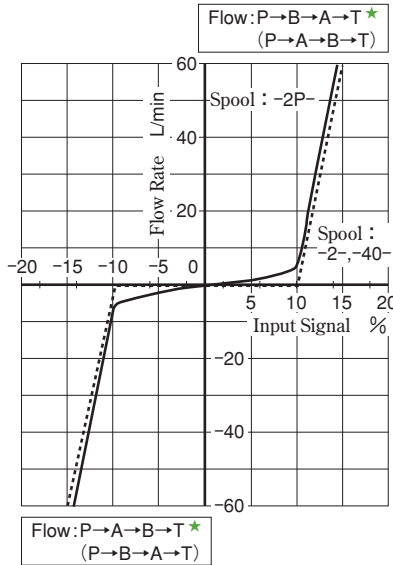
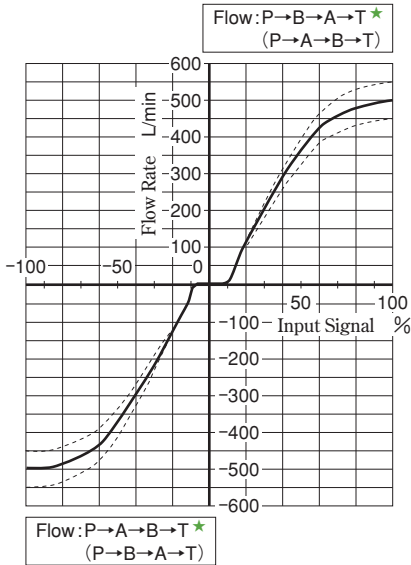

Load Flow Characteristics

<Conditions> ● Input Signal : 100 %
 Note) Tolerance for Load Flow : ±10 %

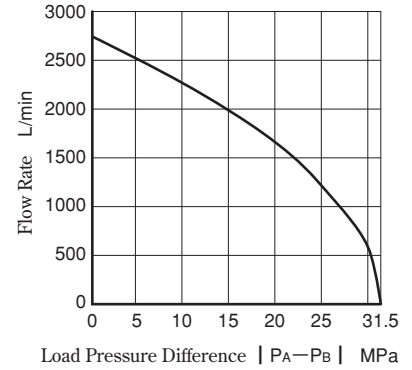

★ The flow outside of parentheses is achieved when the input signal type "A", "B", or "C" is selected. The flow in parentheses is achieved when "D", "E", or "F" is selected.

Step Response

<Conditions> ● Input Signal : 0 ⇔ 100 % ● Supply/Pilot Pressure : 14 MPa

● Pilot Valve: Dry Type

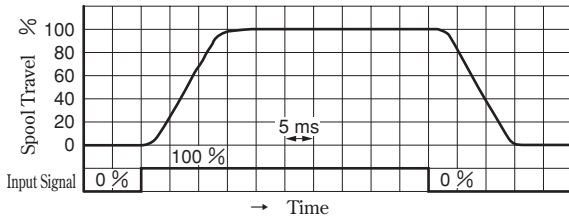

● Pilot Valve: Wet Type

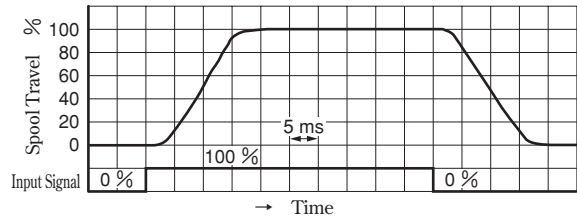

Frequency Response

<Conditions> ● Hydraulic Circuit: Port A/B Closed ● Supply/Pilot Pressure : 14 MPa

● Pilot Valve: Dry Type

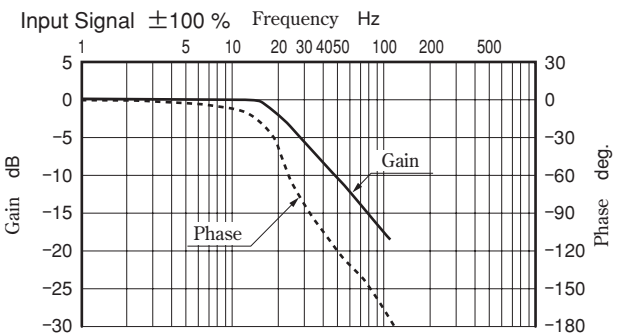
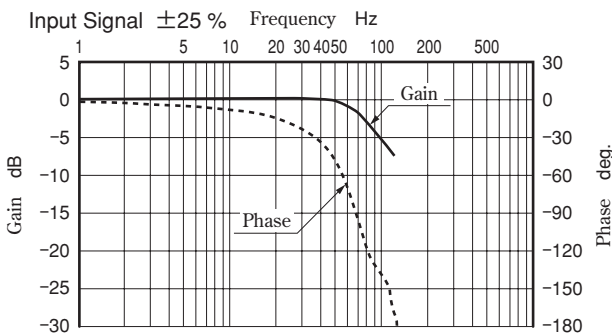

● Pilot Valve: Wet Type

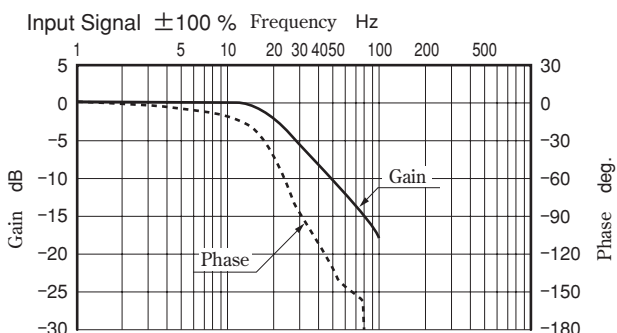
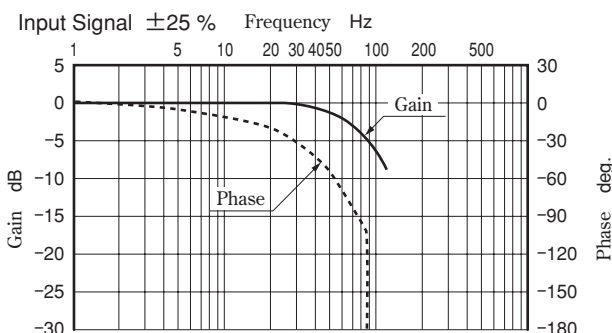

Characteristics of LSVHG-10EH-3800-2/40/2P (Fluid Viscosity: 30 mm²/s)

No-Load Flow Characteristics

<Conditions> ● Valve Pressure Difference: 1 MPa (Pressure Difference per Land: 0.5 MPa)
 Around Null Position Input Signal -20 ⇔ +20 %

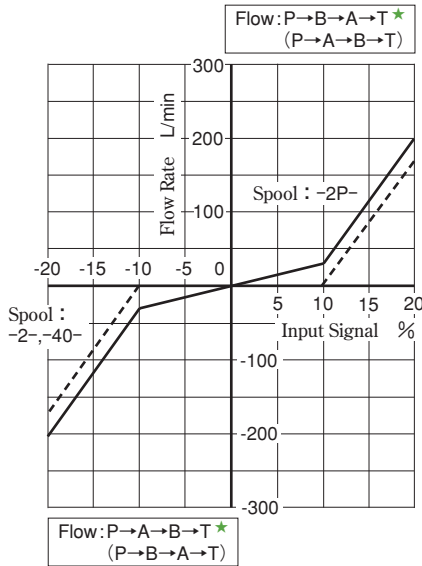
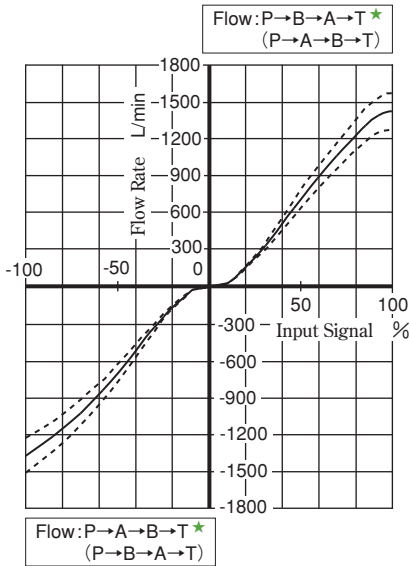

Load Flow Characteristics

<Conditions> ● Input Signal : 100 %
 Note) Tolerance for Load Flow : ±10 %

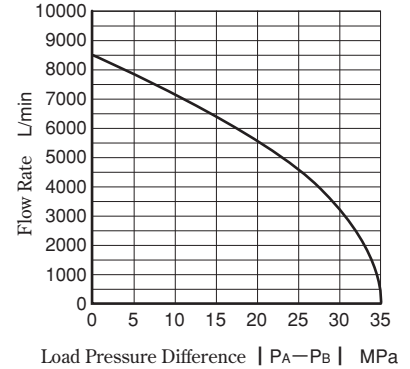

★ The flow outside of parentheses is achieved when the input signal type "A", "B", or "C" is selected. The flow in parentheses is achieved when "D", "E", or "F" is selected.

Step Response

<Conditions> ● Input Signal : 0 ⇔ 100 % ● Supply/Pilot Pressure : 14 MPa

● Pilot Valve: Dry Type

● Pilot Valve: Wet Type

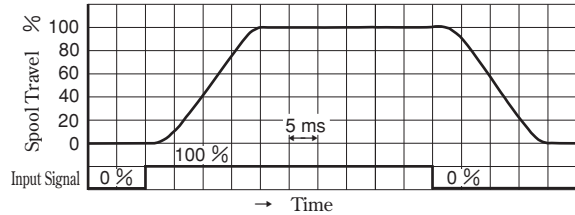
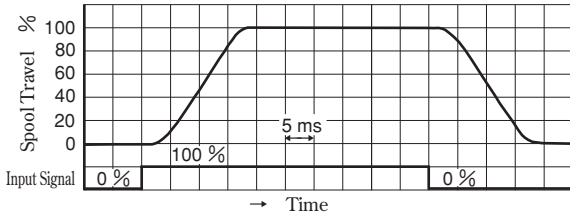

Frequency Response

<Conditions> ● Hydraulic Circuit: Port A/B Closed ● Supply/Pilot Pressure : 14 MPa

● Pilot Valve: Dry Type

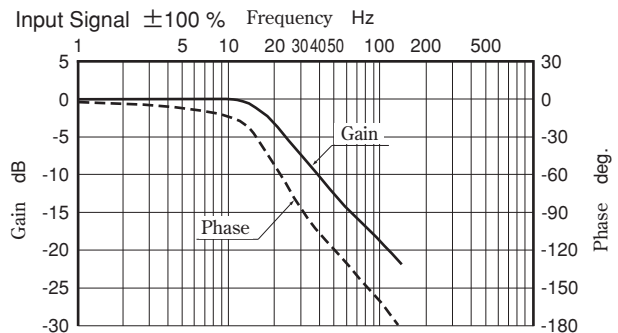
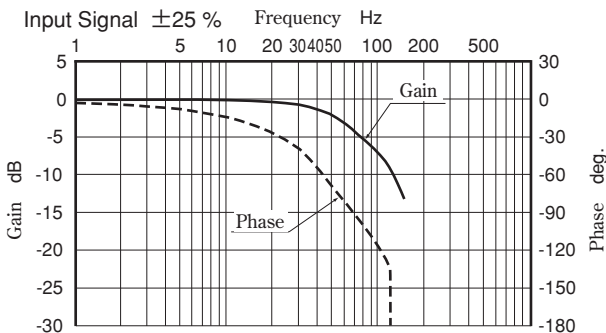

● Pilot Valve: Wet Type

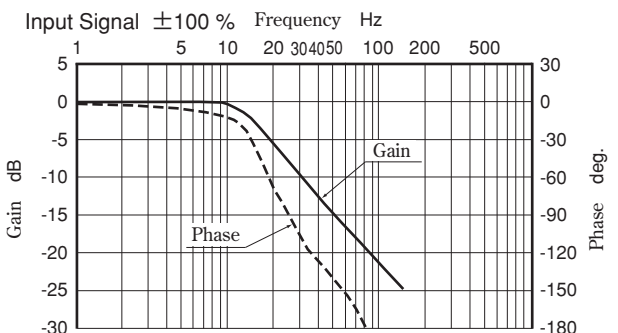
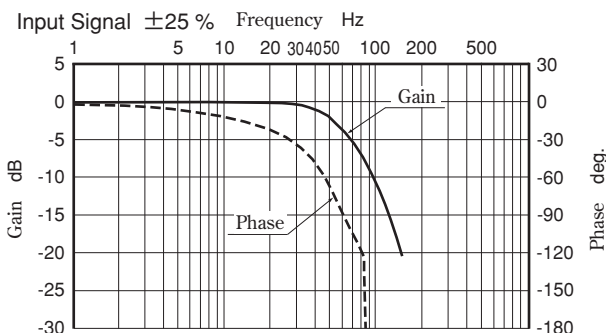

Characteristics of LSVHG-10EH-3800-2L (Fluid Viscosity: 30 mm²/s)

No-Load Flow Characteristics

<Conditions> ● Valve Pressure Difference: $\Delta P = 1 \text{ MPa}$ (4-Way Valve) (Pressure Difference per Land: 0.5 MPa)

Around Null Position Input Signal -20 \leftrightarrow +20 %

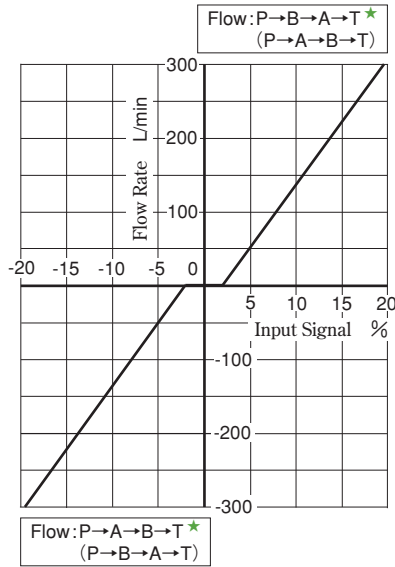
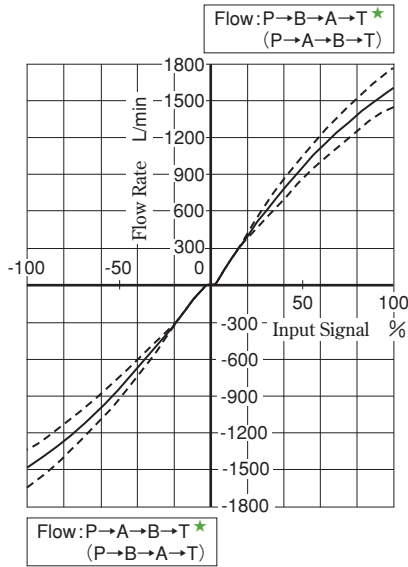

The load flow characteristics, step response, and frequency response are the same as those of the spool types "2", "40", and "2P".

★ The flow outside of parentheses is achieved when the input signal type "A", "B", or "C" is selected. The flow in parentheses is achieved when "D", "E", or "F" is selected.

OBE (On-Board Electronics) type Linear Servo Valves (High Performance Type)

On-board electronics (OBE) type linear servo valves (high performance type) are produced for achieving higher accuracy and durability by incorporating a sleeve in the main stage of the OBE type linear servo valves (standard type), which have been well accepted for their "high accuracy, easiness to use, and great usability". Since the spool and the sleeve are processed to fit well and properly keep 1% overlap between one another, they are suited to be used for a system requiring high accuracy and durability.

● **High accuracy**

As is the case with the standard type valves, all of the OBE type linear servo valves (high performance type) have a low hysteresis of 0.1 % or less, realizing high accuracy. These valves allow the main unit to operate with much higher repeatability.

● **High response characteristics**

Compared to other equivalent models, these valves provide higher levels of step and frequency responses, which are typically used as measures of response characteristics; the step response is 7 ms (0 => 100 %)★, and the frequency response is 110 Hz/-3 dB (± 25 % amplitude)★. (★ : Representative values for LSVHG-03EH- * -S *)

● **Easiness to use**

These valves can offer high accuracy for hydraulic control systems just with 24 V DC power supply and command signal input.

Six types of input signals in three input voltage/current ranges are available:
0 - ±10 V, 0 - ±10 mA, and 4 - 20 mA.

● **Great usability**

The small amplifier in the valves has a fault indicator lamp. This lamp indicates an error when valve failure causes any deviation between the spool position commanded by the signal and the actual spool position. It facilitates you to immediately troubleshoot the failure of the valves, if any.

● **Excellent contamination resistance**

As is the case with the high speed linear servo valves, the OBE type linear servo valves have a simple pilot valve structure, exhibiting excellent contamination resistance. The permissible level of fluid contamination for these valves is up to NAS 1638 class 10.

● **Two types of pilot valves available**

There are two types of pilot valves available: a dry type good in response characteristics and a wet type that eliminates the drain (DR) port to improve usability. They can be selected according to users' purposes.

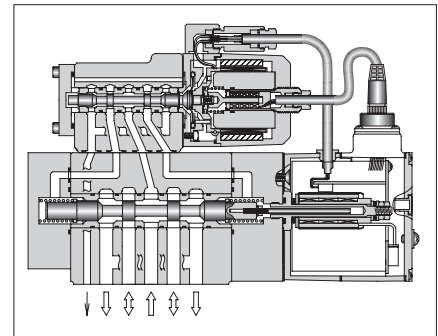
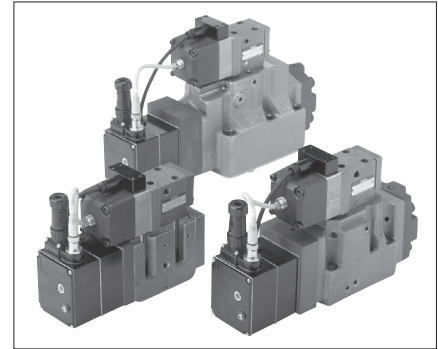

Graphic Symbols

● **4-Way Valve**

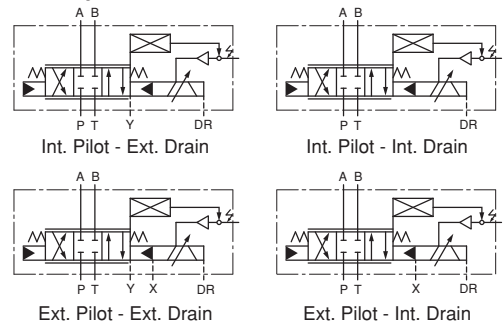

● **3-Way Valve**

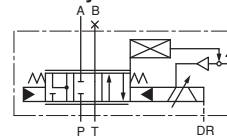

Note) The pilot/drain types are the same as those for the "4-Way Valve" shown above.

■ **Model Number Designation**

F—	LSVHG	—06	EH	—900	—S	4	—E	T	—W	A	—A	1	—20
Fluid Type	Series Number	Valve Size	Amp. Type	Rated Flow @ ΔP=7 MPa	Spool Type	Control Type	Pilot Type	Drain Type	DR Port and Permissible Back Pres.	Fail-safe Function	Input Signal/ Spool Travel Monitoring	Connector Type	Design Number
F : Special Seals for Phosphate Ester Type Fluid (Omit if not required)	LSVHG : Two Stage Type Linear Servo Valves	03	EH : OBE Type	60 : 60 L/min 100 : 100 L/min 160 : 160 L/min	S : 1 % Overlap	3 : 3-Way Valve★1 (Port A is used.) 4 : 4-Way Valve	None: Internal Pilot	None: External Drain	None: With DR Port (Permissible Back Pres.: 0.05 MPa)	None: Position Valve Opening: Full	A: Voltage Signal ± 10 V (P→B→A→T Flow with Input Signal (+)) B: Current Signal 4 - 20 mA (P→B→A→T Flow with Current Signal 12 - 20 mA) C: Current Signal ± 10 mA (P→B→A→T Flow with Input Signal (+)) D: Voltage Signal ± 10 V (P→A→B→T Flow with Input Signal (+)) E: Current Signal 4 - 20 mA (P→A→B→T Flow with Current Signal 12 - 20 mA) F: Current Signal ± 10 mA (P→A→B→T Flow with Input Signal (+))	1: 6+ PE Pole 2: 11+ PE Pole	20
		04		100 : 100 L/min 200 : 200 L/min 280 : 280 L/min 450 : 450 L/min									
		06		500 : 500 L/min 900 : 900 L/min									

★1. For the valves with a 3-way valve and a fail-safe solenoid operated valve, select "EB" for the fail-safe function type and "D", "E", or "F" for the input signal/spool travel monitoring type.
★2. The valves with the model number "W" (without DR port) cannot use water-glycol fluids.

Specifications

The values in parentheses in the specification table below are applicable to the models "LSVHG-*EH-*S*-*W*-" (without DR port).

Descriptions		Model Numbers						LSVHG-03EH- *-S*						LSVHG-04EH- *-S*						LSVHG-06EH- *-S*				
Spool Type		S4			S3			S4			S3			S4		S3								
Rated Flow @ $\Delta P = 7$ MPa (4-Way Valve) L/min		60	100	160	—	—	—	100	200	280	450	—	—	—	—	500	900	—	—					
Rated Flow @ $\Delta P = 3.5$ MPa (3-Way Valve) L/min		—	—	—	60	100	160	—	—	—	—	100	200	280	450	—	—	500	900					
Max. Operating Pressure MPa		31.5						35						35										
Proof Pres. at Return Port ⁽¹⁾	External Drain	T Port	MPa						21						35									
		Y Port	MPa						21 ⁽⁷⁾ (7)						21 (7)									
	Internal Drain	T & Y Ports	MPa						21 ⁽⁷⁾ (7)						21 (7)									
DR Port Permissible Back Pressure ⁽²⁾ MPa		0.05 (The valves with the model number "W" have no DR port.)																						
Pilot Pressure ⁽³⁾ MPa		1.5 - 21																						
Pilot Flow Rate ⁽⁴⁾ L/min		4 or more						6 or more						21 or more										
Pilot Valve Max. Leakage	Pres.: $P_s = P_p = 14$ MPa Fluid Viscosity: 32 mm ² /s	L/min																						
Main Valve Max. Leakage		0.6						1.1						2.5						1.2				
Hysteresis %		0.1 or less																						
Step Response (0 \leftrightarrow 100 %, Typical) ⁽⁵⁾ ms		7 (8)						11 (12)						12 (13)										
Frequency Response (± 25 % Amplitude Typical) ⁽⁶⁾	Gain: -3 dB	Hz						110 (80)						100 (80)						100 (80)				
	Phase: -90°	Hz						110 (90)						100 (90)						95 (90)				
Vibration Proof ⁽⁶⁾ m/s ²		100																						
Protection		IP 65																						
Ambient Temperature °C		0 - +50																						
Spool Stroke to Stops mm		± 3.5						± 3.5						± 5										
Spool End Area cm ²		1.3						3.1						8										
Linear Motor Specification	Current	A																						
	Coil Resistance	Ω																						
Approx. Mass ⁽⁸⁾ kg		8.5 [11]						14 [16]						20 [24]										
Mounting Surface		ISO 4401-05-05-0-05						ISO 4401-07-06-0-05						ISO 4401-08-07-0-05										
Electric Connection		6 + PE/11 + PE Connector (EN175201 Part 804)																						

- Note) ⁽¹⁾ Pressure at the return port should be at actual supply pressure or less.
⁽²⁾ Back pressure at the drain port should be 0.05 MPa or less and not be a negative pressure. For the valves with the model number "W", no drain port connection is required.
⁽³⁾ Supply pressure for the pilot valve should be 1.5 - 21 MPa and should also be 60% of actual supply pressure or more.
⁽⁴⁾ The pilot flow is calculated based on a pilot pressure of 14 MPa and the above step response.
⁽⁵⁾ This value is measured for each valve based on a pilot pressure of 14 MPa; it may vary depending on the actual circuit/operation conditions.
⁽⁶⁾ There are restrictions on the mounting position; refer to the instructions for details.
⁽⁷⁾ To use an external pilot type valve with a supply pressure of 21 MPa or more, pressures at the T and Y ports should be 7 MPa or less.
⁽⁸⁾ A value in brackets indicates the mass of each valve with a fail-safe solenoid operated valve.
⁽⁹⁾ For the effective range of the fail-safe function, see page I-60.

Accessories/Electrical Specifications/Block Diagram

These are the same as those of the standard type. See the relevant pages.

Item	Page for Reference
Accessories	I-35
Electrical Specifications	I-36
Block Diagram	I-37

LSVHG-03EH-60/100/160-S *

Mounting Surface: Conforming to ISO 4401-05-05-0-05

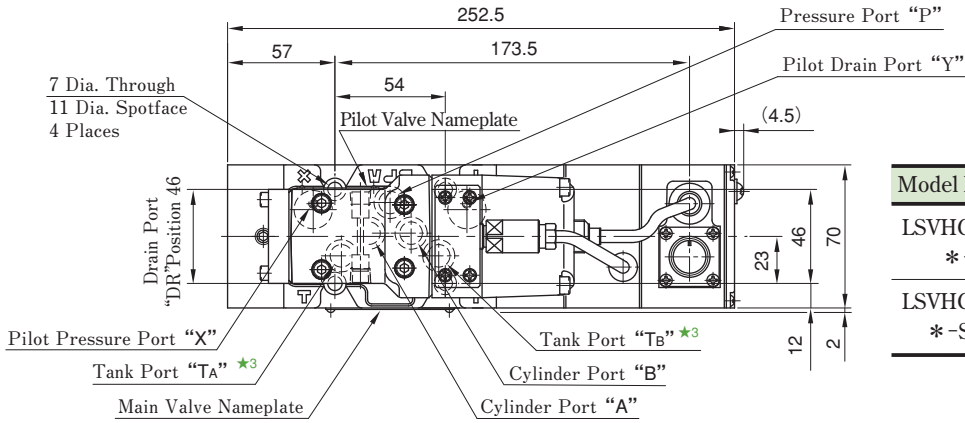

Model Numbers	C	Remarks
LSVHG-03EH- *-S*	168	Pilot Valve: Dry Type
LSVHG-03EH- *-S*-W	177	Pilot Valve: Wet Type

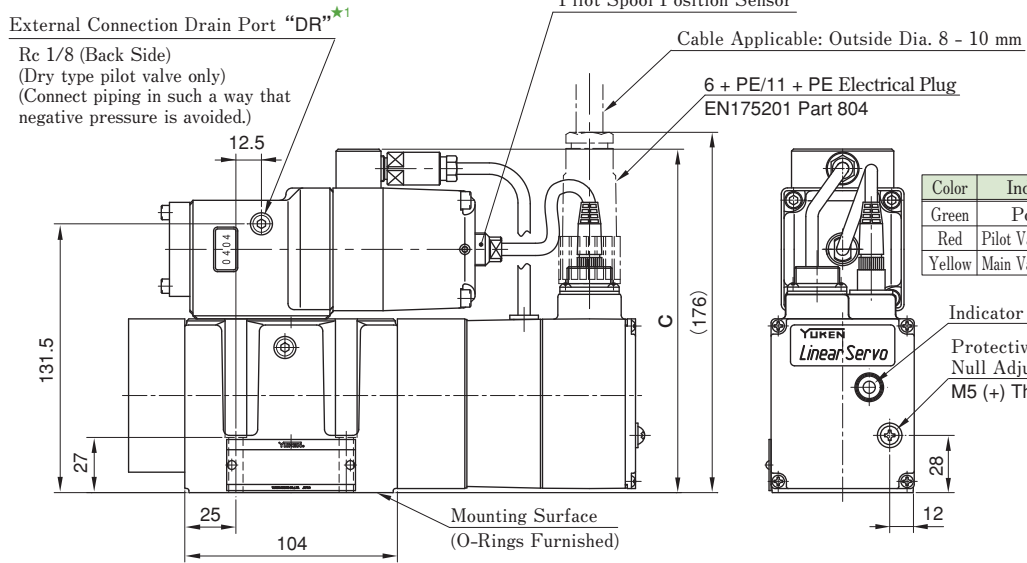

Color	Indicator Lamp
Green	Power Supply
Red	Pilot Valve Deviation Alarm
Yellow	Main Valve Deviation Alarm

- ★1. The external connection drain port "DR" on the front side is usually plugged. To use the port on the front side, remove the hexagon socket head plug (5 Hex.) and plug the port on the back side.
- ★2. To adjust the null, remove the protective screw and turn the null trimmer. After adjustment, be sure to attach the protective screw.
- ★3. There are two tank ports "TA" and "TB" ; however, "TA" may be used alone.

**LSVHG-03EH-60/100/160-S * - * EA/EB
(With Fail-safe Solenoid Operated Valve)**

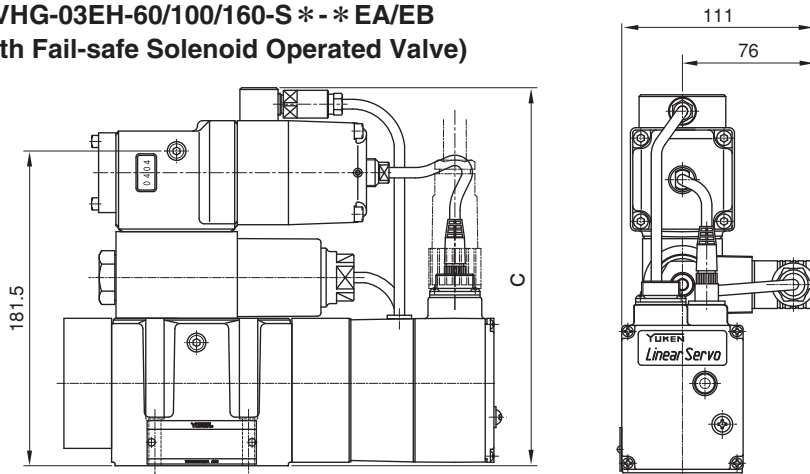

[Dimensions of Mounting Surface]
The dimensions of the mounting surface are the same as those of the models LSVHG-03EH (page I-38).

Detailed Graphic Symbol

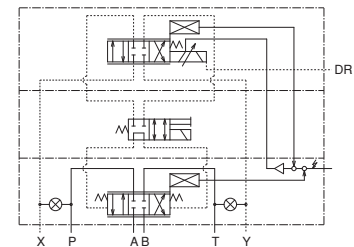

⊗ : Plugs for selecting the pilot and drain types

● O-Rings for the Ports

Port	O-Ring Size	Qty.
P, A, B, T	AS568-014 (NBR-90)	5
X, Y	AS568-016 (NBR-90)	2

O-Rings made of fluorinated rubber are required to use phosphate ester type fluids.

Model Numbers	C	Remarks
LSVHG-03EH- *-S*-E*	218	Pilot Valve: Dry Type
LSVHG-03EH- *-S*-WE*	227	Pilot Valve: Wet Type

● For other dimensions, see the figures above (the models without a fail-safe solenoid operated valve).

LSVHG-04EH-100/200/280/450-S *

Model Numbers	C	Remarks
LSVHG-04EH- *-S*	194	Pilot Valve: Dry Type
LSVHG-04EH- *-S*-W	203	Pilot Valve: Wet Type

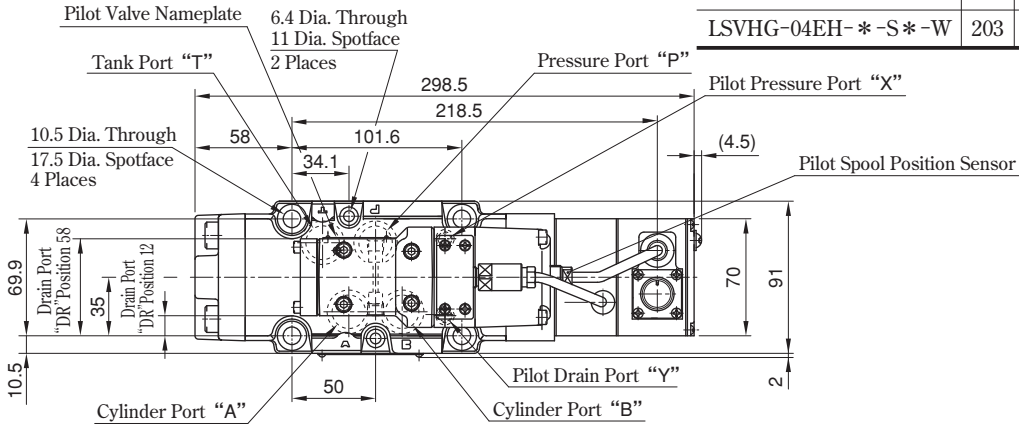

External Connection Drain Port "DR" ^{★1}

Rc 1/8 (Back Side)
(Dry type pilot valve only.)
(Connect piping in such a way that negative pressure is avoided.)

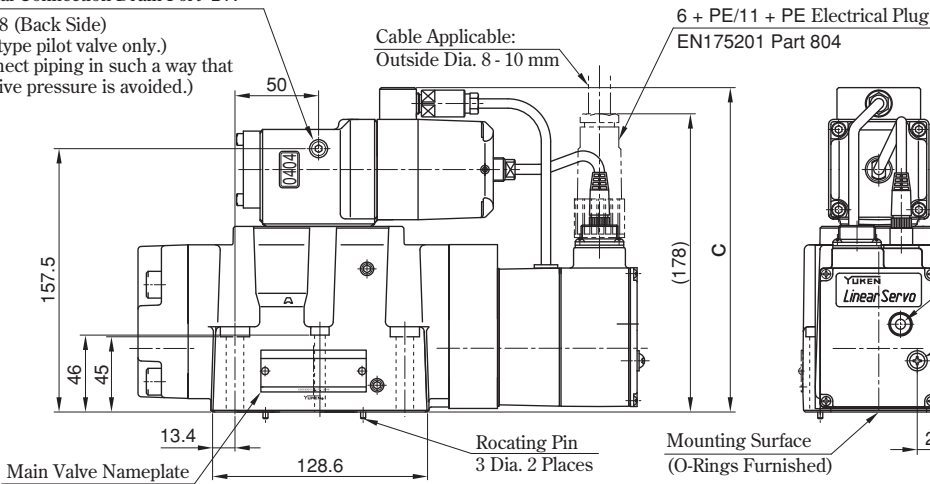

Color	Indicator Lamp
Green	Power Supply
Red	Pilot Valve Deviation Alarm
Yellow	Main Valve Deviation Alarm

- ★1. The external connection drain port "DR" on the front side is usually plugged. To use the port on the front side, remove the hexagon socket head plug (5 Hex.) and plug the port on the back side.
- ★2. To adjust the null, remove the protective screw and turn the null trimmer. After adjustment, be sure to attach the protective screw.

LSVHG-04EH-100/200/280/450- * S- * EA/EB (With Fail-safe Solenoid Operated Valve)

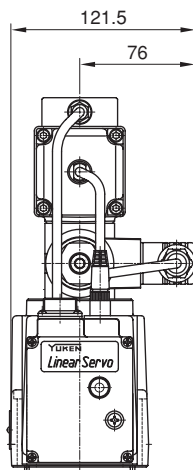
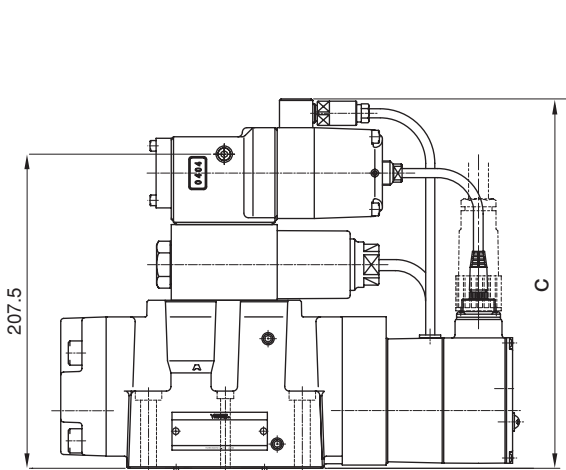

[Dimensions of Mounting Surface]

The dimensions of the mounting surface are the same as those of the models LSVHG-04 (page I-12).

Detailed Graphic Symbol

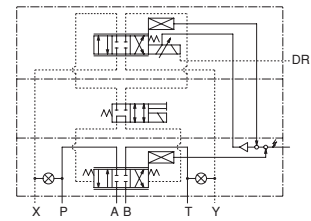

● O-Rings for the Ports

Port	O-Ring Size	Qty.
P, A, B, T	OR NBR-90 P22-N	4
X, Y	AS568-012 (NBR-90)	2

O-Rings made of fluorinated rubber are required to use phosphate ester type fluids.

Model Numbers	C	Remarks
LSVHG-04EH- *-S*-E*	244	Pilot Valve: Dry Type
LSVHG-04EH- *-S*-WE*	253	Pilot Valve: Wet Type

● For other dimensions, see the figures above (the models without a fail-safe solenoid operated valve).

LSVHG-06EH-500/900-S *

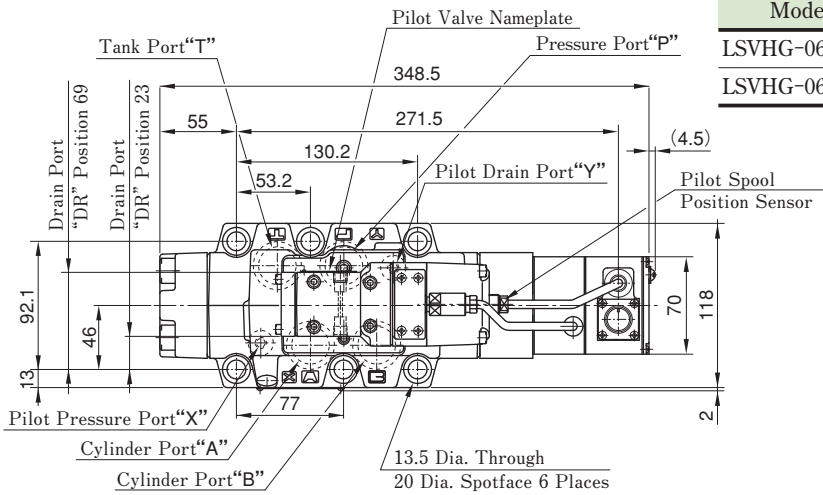

Model Numbers	C	Remarks
LSVHG-06EH- *-S*	220	Pilot Valve: Dry Type
LSVHG-06EH- *-S*-W	229	Pilot Valve: Wet Type

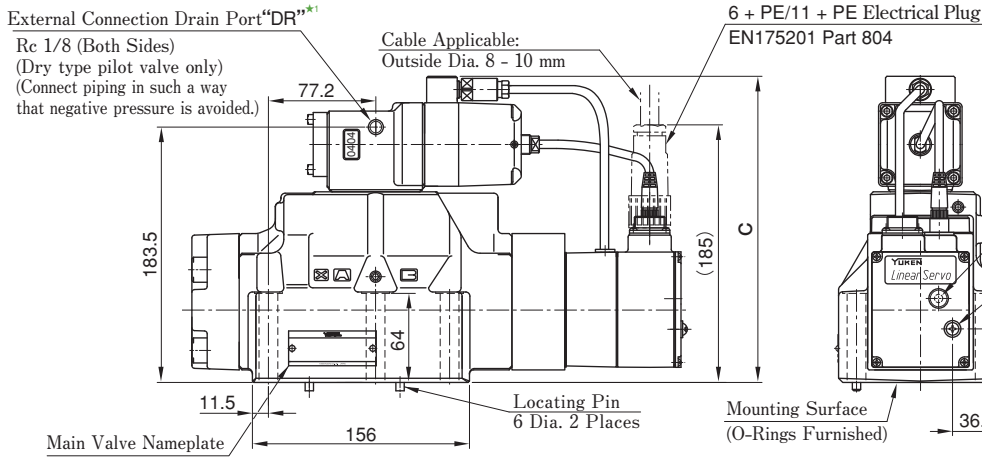

Color	Indicator Lamp
Green	Power Supply
Red	Pilot Valve Deviation Alarm
Yellow	Main Valve Deviation Alarm

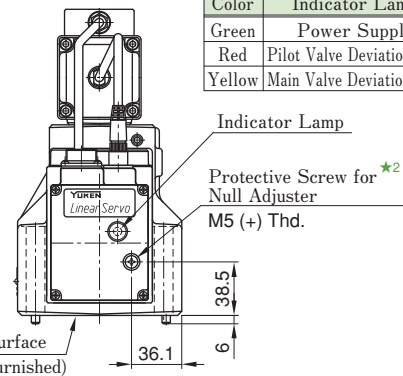

- ★1. The external connection drain port "DR" on the back side is usually plugged. To use the port on the back side, remove the hexagon socket head plug (5 Hex.) and plug the port on the front side.
- ★2. To adjust the null, remove the protective screw and turn the null trimmer. After adjustment, be sure to attach the protective screw.

LSVHG-06EH-500/900- * S- * EA/EB (With Fail-safe Solenoid Operated Valve)

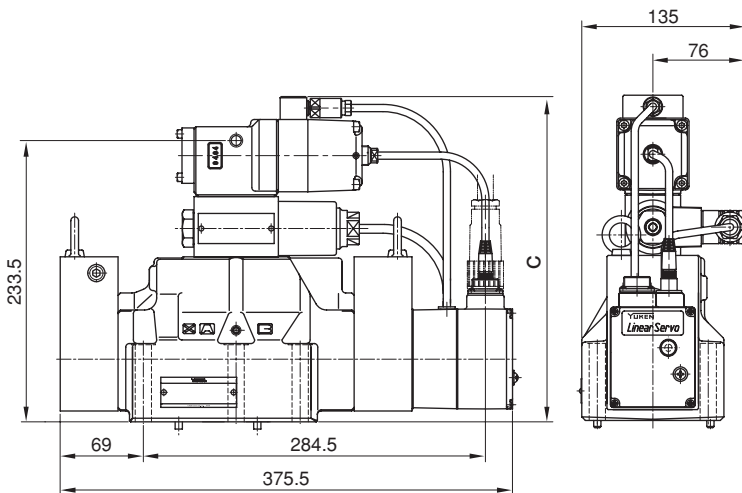

Detailed Graphic Symbol

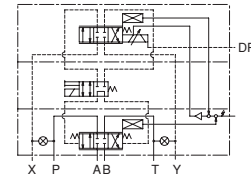

⊗: Plugs for selecting the pilot and drain types

Model Numbers	C	Remarks
LSVHG-06EH- *-S*-E*	270	Pilot Valve: Dry Type
LSVHG-06EH- *-S*-WE*	279	Pilot Valve: Wet Type

● For other dimensions, see the figures above (the models without a fail-safe solenoid operated valve).

● O-Rings for the Ports

Port	O-Ring Size	Qty.
P, A, B, T	AS568-123 (NBR-90)	4
X, Y	OR NBR-90 P14-N	2

O-Rings made of fluorinated rubber are required to use phosphate ester type fluids.

[Dimensions of Mounting Surface]

The dimensions of the mounting surface are the same as those of the models LSVHG-06-900 (page I-13).

Characteristics of LSVHG-03EH-60/100/160-S * (Fluid Viscosity: 30 mm²/s)

No-Load Flow Characteristics

Valve Pressure Difference: $\Delta P = 7 \text{ MPa}$ (Constant)
(4-Way Valve)

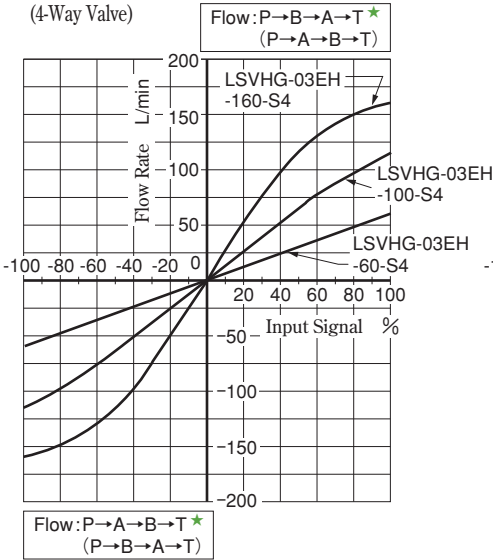

Valve Pressure Difference: $\Delta P = 3.5 \text{ MPa}$ (Constant)
(3-Way Valve)

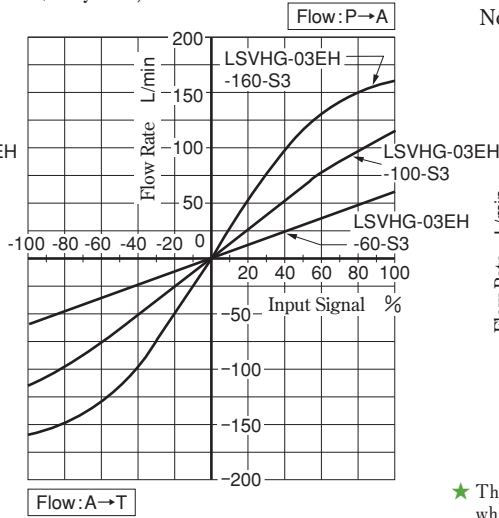

Load Flow Characteristics

<Conditions>

● Input Signal : 100 %

Note) Tolerance for Load Flow : $\pm 10 \%$

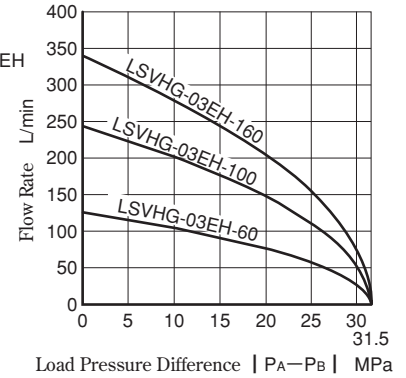

★ The flow outside of parentheses is achieved when the input signal type "A", "B", or "C" is selected. The flow in parentheses is achieved when "D", "E", or "F" is selected.

Step Response

<Conditions> ● Input Signal : 0 ⇔ 100 % ● Supply/Pilot Pressure : 14 MPa

Pilot Valve: Dry Type

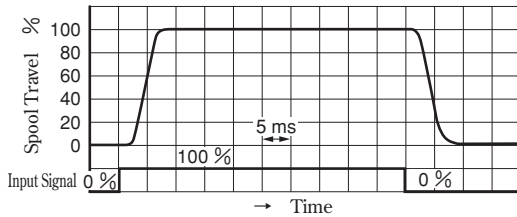

Pilot Valve: Wet Type

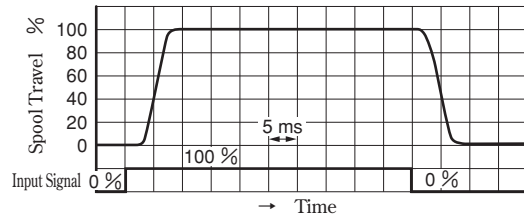

Frequency Response

<Conditions> ● Hydraulic Circuit: Port A/B Closed ● Supply/Pilot Pressure : 14 MPa

Pilot Valve: Dry Type

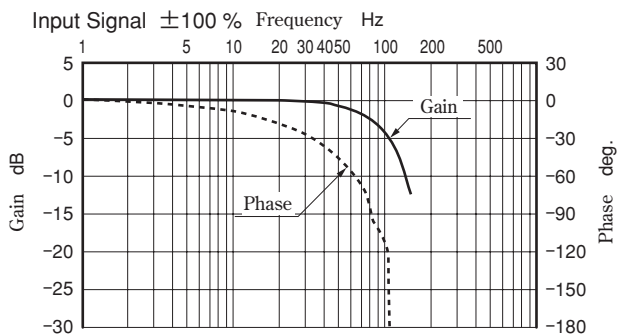
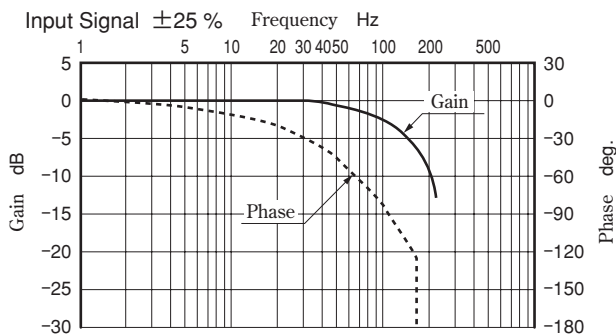

Pilot Valve: Wet Type

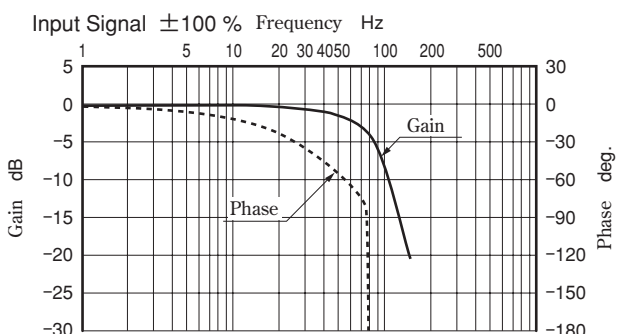
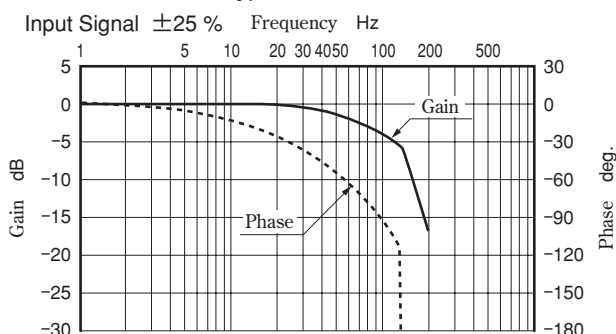

Characteristics of LSVHG-04EH-100/200/280/450-S* (Fluid Viscosity: 30 mm²/s)

No-Load Flow Characteristics

Valve Pressure Difference: $\Delta P = 7 \text{ MPa}$ (Constant)
(4-Way Valve)

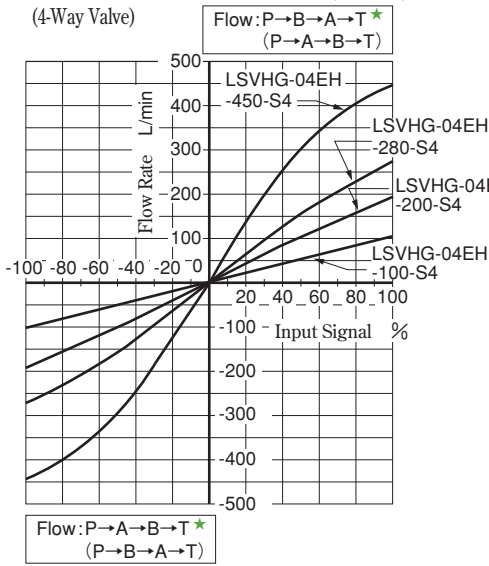

Valve Pressure Difference: $\Delta P = 3.5 \text{ MPa}$ (Constant)
(3-Way Valve)

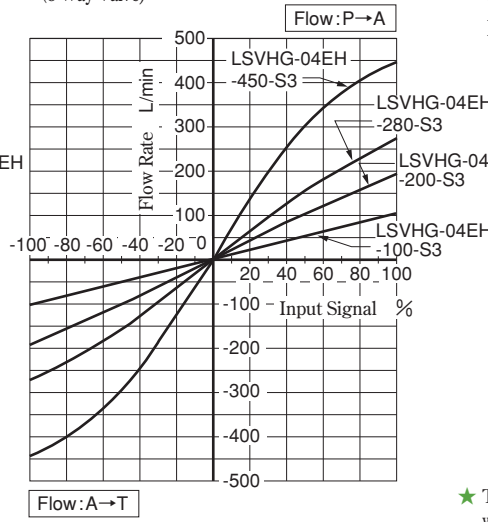

Load Flow Characteristics

<Conditions>

● Input Signal : 100 %

Note) Tolerance for Load Flow : $\pm 10 \%$

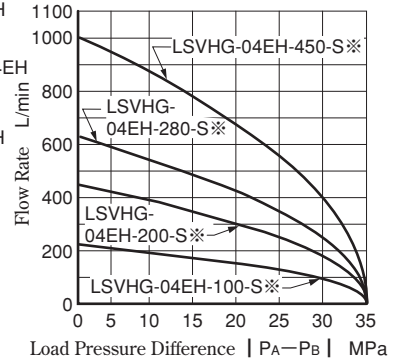

★ The flow outside of parentheses is achieved when the input signal type "A", "B", or "C" is selected. The flow in parentheses is achieved when "D", "E", or "F" is selected.

Step Response

<Conditions> ● Input Signal : 0 ⇄ 100 % ● Supply/Pilot Pressure : 14 MPa

● Pilot Valve: Dry Type

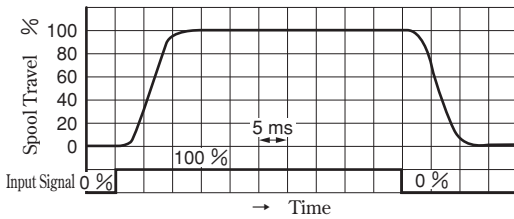

● Pilot Valve: Wet Type

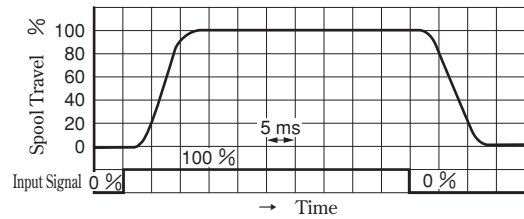

Frequency Response

<Conditions> ● Hydraulic Circuit: Port A/B Closed ● Supply/Pilot Pressure : 14 MPa

● Pilot Valve: Dry Type

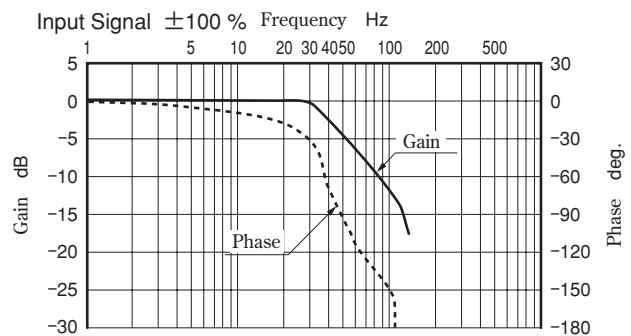
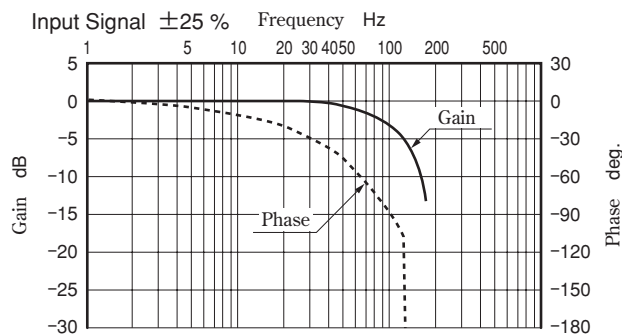

● Pilot Valve: Wet Type

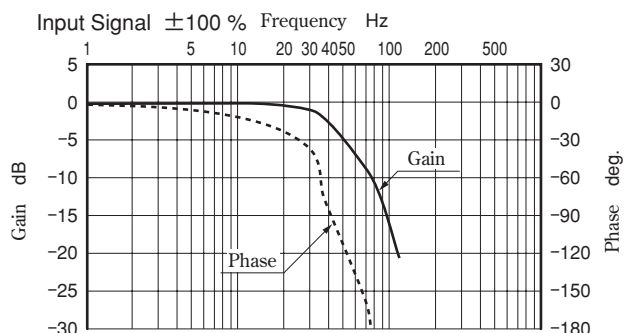
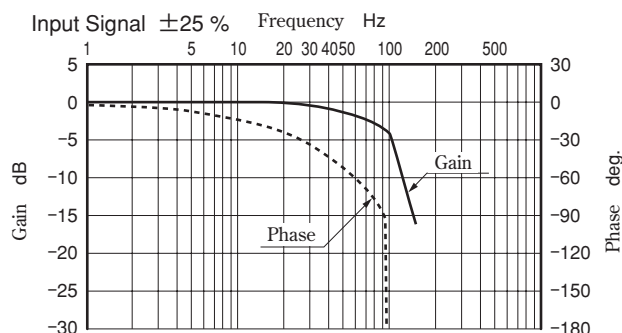

Characteristics of LSVHG-06EH-500/900-S * (Fluid Viscosity: 30 mm²/s)

No-Load Flow Characteristics

Valve Pressure Difference: $\Delta P = 7 \text{ MPa}$ (Constant)
(4-Way Valve)

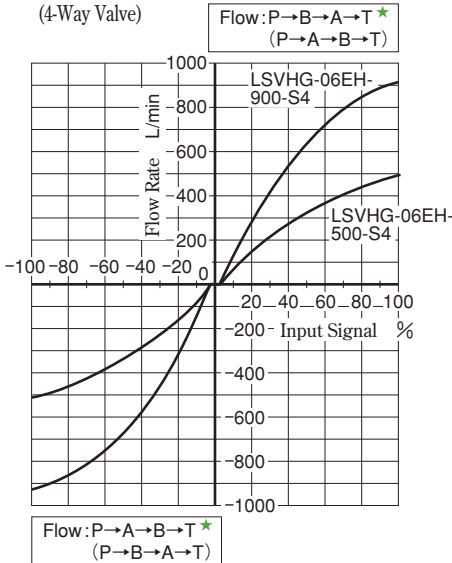

Valve Pressure Difference: $\Delta P = 3.5 \text{ MPa}$ (Constant)
(3-Way Valve)

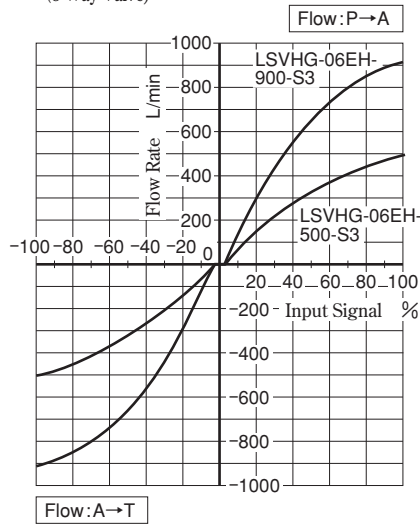

Load Flow Characteristics

<Conditions>

● Input Signal : 100 %

Note) Tolerance for Load Flow : $\pm 10 \%$

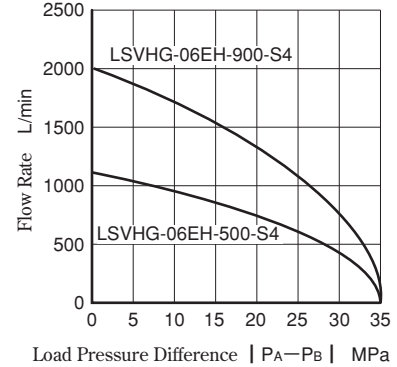

★ The flow outside of parentheses is achieved when the input signal type "A", "B", or "C" is selected. The flow in parentheses is achieved when "D", "E", or "F" is selected.

Step Response

<Conditions> ● Input Signal : 0 \leftrightarrow 100 % ● Supply/Pilot Pressure : 14 MPa

Pilot Valve: Dry Type

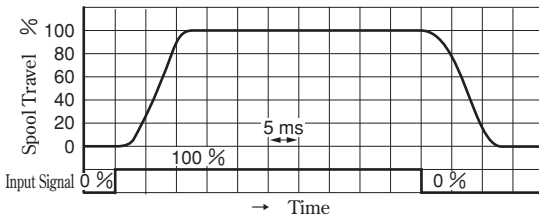

Pilot Valve: Wet Type

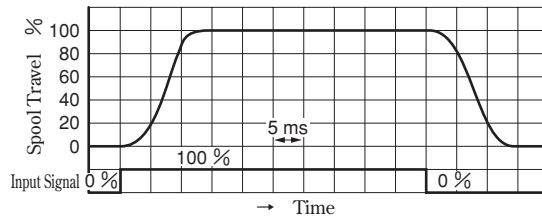

Frequency Response

<Conditions> ● Hydraulic Circuit: Port A/B Closed ● Supply/Pilot Pressure : 14 MPa

Pilot Valve: Dry Type

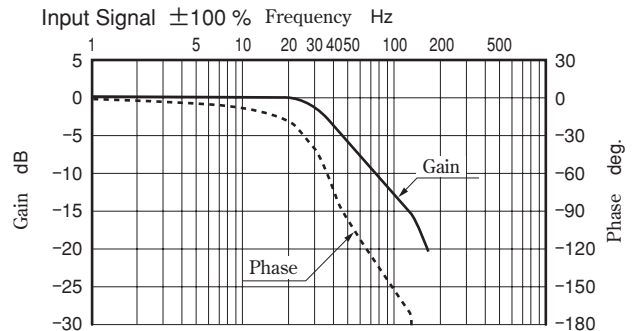
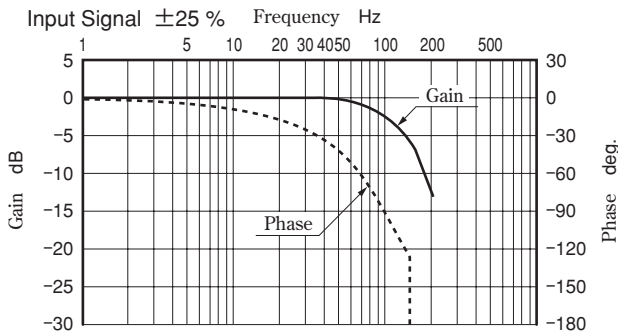

Pilot Valve: Wet Type

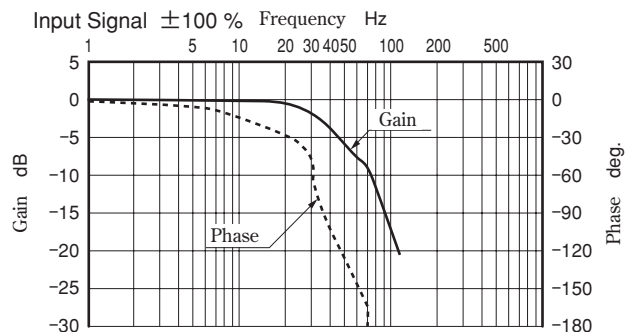
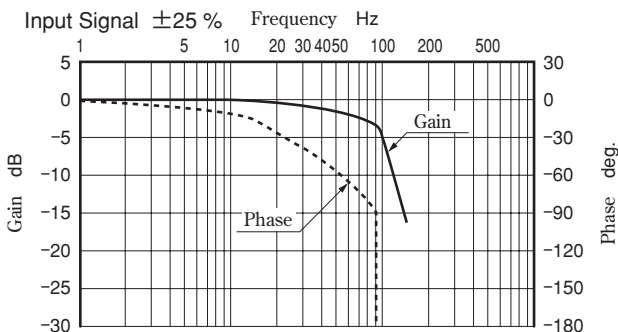

Effective Ranges of the Fail-safe Function for OBE (On-Board Electronics) Type Linear Servo Valves

- LSVHG-03EH-230/270-
- LSVHG-03EH-210-4J-
- LSVHG-03EH-60/100/160-S4-

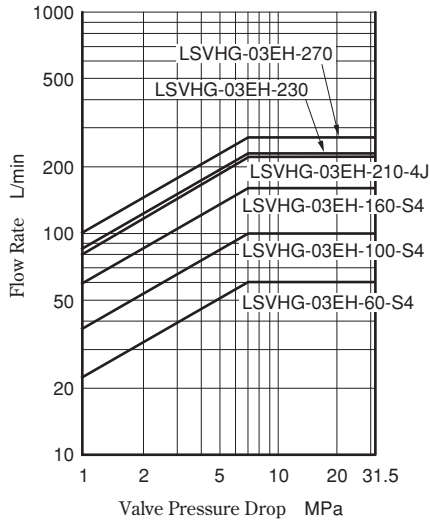

- LSVHG-03EH-60/100/160-S3-

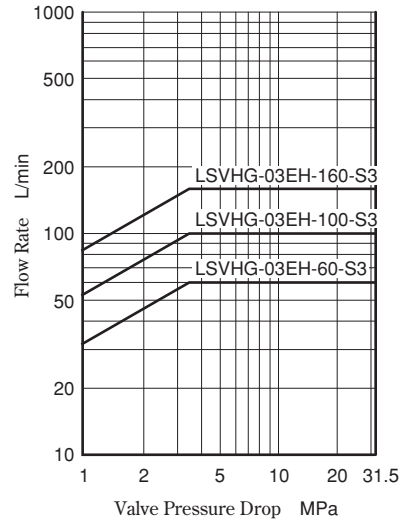

- LSVHG-04EH-750-
- LSVHG-04EH-580-4J-
- LSVHG-04EH-100/200/280/450-S4-

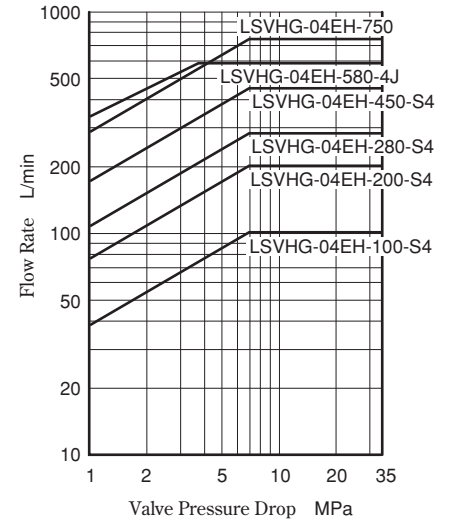

- LSVHG-04EH-100/200/280/450-S3-

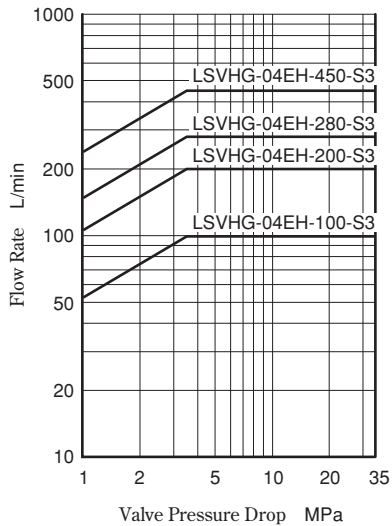

- LSVHG-06EH-900/1300
- LSVHG-06EH-820-4J-
- LSVHG-06EH-500/900-S4-

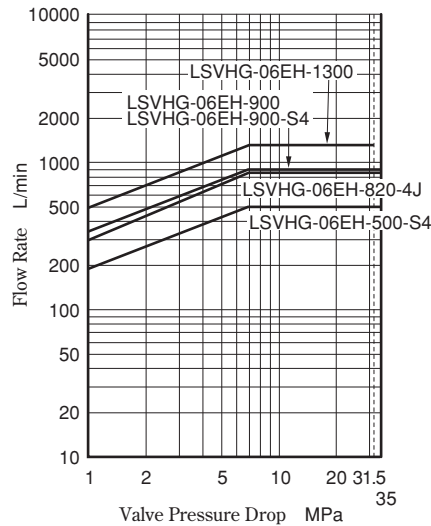

- LSVHG-06EH-500/900-S3-

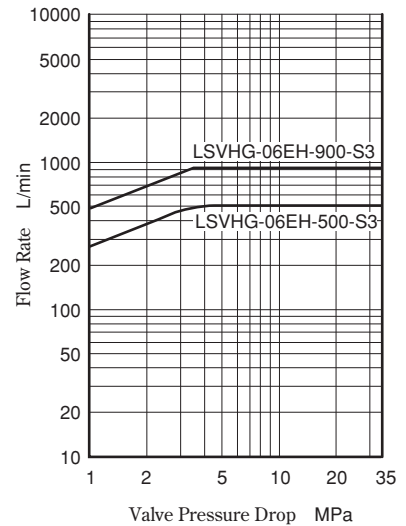

- LSVHG-10EH-3800-

