

The World's Highest Level of High Pressure, High Flow and Low Pressure Drop

DSG-01 Series Solenoid Operated Directional Valves

These Solenoid Operated Directional Valves realized the world's highest level of high pressure, high flow and low pressure drop, the features of which can be materialized by employing a powerful wet type solenoid and the rational flow channel design including 5 chamber system.

● High Pressure & High Flow Rate

In comparison to our existing lines, both the pressure and flow of these valves are much increased.

- Max. Operating Pressure: approx. 10 % increased [31.5→35 MPa]
- Max. T-Line Back Pressure: approx. 30 % increased [16→21 MPa]
- Max. Flow : approx. 60 % increased [63→100 L/min]

● Low Pressure Drop

The pressure drop of these valves is reduced by 10 % from 1.0 to 0.9 MPa, in comparison to our existing lines*; the valves effectively reduce the energy consumption of the unit.

★At Flow Rate: 60 L/min, Spool Type: 3C2 (P→A)

● Compact & Small Mass

Despite of high pressure, high flow and low pressure drop, these valve bodies are compact and lightweight with DC double solenoids; the overall length and mass are reduced from 210 to 205 mm and from 2.2 to 1.85 kg, respectively.

● Shockless type available

In addition to the standard valves for high pressure and high flow, a shockless type capable of minimizing noise and vibration in piping during spool changeover is also available.

● Stable Operation

Due to the powerful magnetic and spring force of the solenoids, these valves exhibit a high tolerance to contaminants and especially stable operation.

● IP65-equivalent high dust- and water-proof

These valves demonstrate excellent dust- and water-proof characteristics, in compliance with I. E. C. Pub. 529. IP65 and JIS C 0920 IP65 (dust- and jet-proof type). The Deutsch Connector Type in compliance with IP67 is also available.

● Usable in products of various standards

These standard valves are CE certified for installation in equipment overseas. UL/CSA certified products are also available. (UL/CSA certified products are special design products, so for details, please contact us.)

● Various Type of Connection

In addition to the current Terminal Box Type and Plug-in Connector Type, according usage you can select M12-4 Pin Connector Type suitable for serial transfer, Center Plug-in Connector Type to contribute shortening the wiring man-hour, Deutsch Connector Type with good water-proof characteristics.

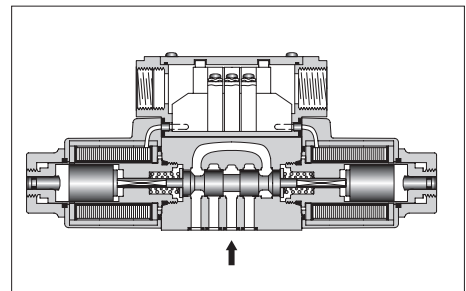
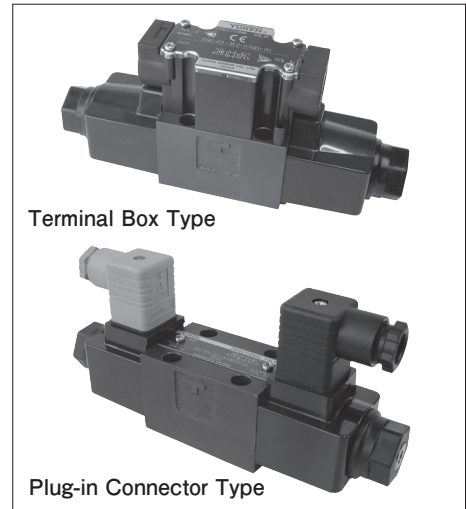

■ Specifications

Valve Type	Model Numbers	Max. Flow*2 L/min	Max. Operating Pressure MPa	Max. T-Line Back Pressure MPa	Max. Changeover Frequency min ⁻¹	Mass kg
Standard Type	DSG-01-3C *- *-70	100	35	21	300 (R Type Sol. Only) 120	1.85
	DSG-01-2D2 *- *-70					1.4
	DSG-01-2B *- *-70					1.4
Shockless Type	S-DSG-01-3C *- *-70	63	25	21	120	1.85
	S-DSG-01-2B2 *- *-70					1.4
Low Wattage (14W) Type*1	L-DSG-01-3C *- *-70	40	16	16	300 (R Type Sol. Only) 120	1.85
	L-DSG-01-2D2 *- *-70					1.4
	L-DSG-01-2N *- *-70					
	L-DSG-01-2B *- *-70					

★1. For details of Low Wattage (14W) Type, please contact us.

★2. The maximum flow means the limited flow without inducing any abnormality to the operation (changeover) of the valve. The maximum flow differs according to the spool type and operating conditions. For details, please refer to the "List of Standard Models" on pages E-25 to E-27.

■ Sub-plates

Sub-plate Model Numbers	Thread Size Rc	Approx. Mass kg
DSGM-01-31	1/8	0.8
DSGM-01X-31	1/4	
DSGM-01Y-31	3/8	

● Sub-plates are available. Specify the sub-plate model number from the table above.

When sub-plates are not used, the mounting surface should have a good machined finish. (L6/)

Solenoid Ratings

Valve Type	Electric Source	Coil Type ^{★3}	Frequency (Hz)	Voltage (V)		Current & Power at Rated Voltage		
				Source Rating	Serviceable Range	Inrush ^{★2} (A)	Holding (A)	Power (W)
Standard Type	AC ^{★1}	A 100	50	100	80 - 110	2.42	0.51	—
			60	100	90 - 120	2.14	0.37	
		A 120 ^{★4}	50	120		96 - 132	2.02	
			60		108 - 144	1.78	0.31	
		A 200	50	200	160 - 220	1.21	0.25	
			60		180 - 240	1.07	0.19	
Shockless Type	A 240 ^{★4}	50	240	192 - 264		1.01	0.21	
		60	216 - 288	0.89	0.15			
DC (K Series)	DC (K Series)	D 12 ^{★4}	—	12	10.8 - 13.2	—	2.45	29
		D 24 ^{★4}		24	21.6 - 26.4		1.23	
		D 48		48	43.2 - 52.8		0.61	
AC→DC Rectified (R)	AC→DC Rectified (R)	R 100	50/60	100	90 - 110	—	0.33	29
		R 200		200	180 - 220		0.16	

- ★1. AC solenoid is not available in shockless type.
R type models with built-in current rectifier is recommended for shockless operation with AC power.
- ★2. Inrush current in the above table show rms values at maximum stroke.
- ★3. There are more coil types other than the above. For details, please make inquiries.
- ★4. UL certified products are only available for the voltages above.

The coil type numbers in the shaded column are handled as optional extras.
In case these coils are required to be chosen, please confirm the time of delivery with us before ordering.

Options

● Push Button with Lock Nut

Can be used for manual changeover of spool. The push button can be locked in the pressed condition.

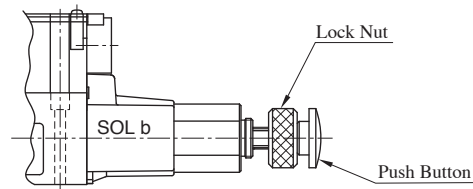

● Plug-in Connector Type

Electrical conduit connecting part is plug-in type, so can mount/dismount valves without disconnecting.

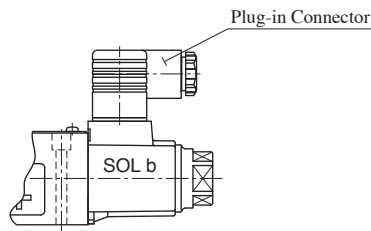

● Plug-in Connector with Solenoid Indicator Light

These are the indicator light incorporated plug-in connector type solenoids. Energisation or de-energisation of the solenoid can be easily identified with the incorporated indicator light.

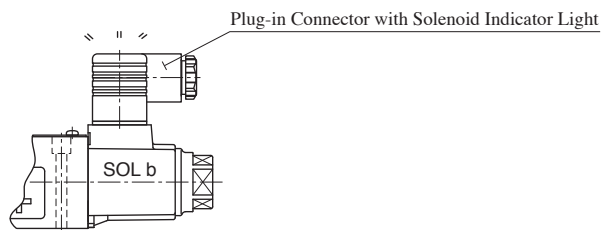

Special connector type (M12-4 Pin Connector Type, Center Plug-in Connector Type, Center Plug-in M12-4 Connector Type, Deutsch Connector Type), refer to pages E-35 & E-36.

Model Number Designation

S-	DSG	-01	-2	B	2	A	-D24	-C	-N ^{★4}	-70	-L	
Shockless Type	Series Number	Valve Size	Number of Valve Positions	Spool Spring Arrangement	Spool Type	Input Only Valves Using Neutral Position & Side Position	Coil Type	Manual Override	Electrical Conduit Connection	Design Number	Models with Reverse Mtg. of Solenoid	
None: Standard Type	DSG: Solenoid Operated Directional Valve (Sub-plate Mounting Type)	01	3	C : Spring Centered	2, 3	—	AC : A100 A120 A200 A240	None: Manual Override Pin	None: Terminal Box Type	70	L : Input only for reverse mtg. of solenoid.	
					4, 40							
			60, 9	2	D : No-Spring Detented	2	—					DC : D12 D24 D48
			10, 11 12									
S : Shockless Type	01	3	C : Spring Centered	2	4	—	DC : D12 D24 D48	C : Push Button and Lock Nut (Option)	N : Plug-in Connector Type (Option)	70	L : Input only for reverse mtg. of solenoid.	
												2
8	A : ★ ¹ Using Neutral Position & SOL a Energised Position	N1 : ★ ² Plug-in Connector Type with Indicator Light (Option)										
B : ★ ¹ Using Neutral Position & SOL b Energised Position												









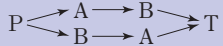
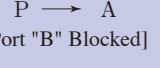
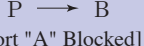

- ★1. In case of Valves Using Neutral Position and Side Position, please refer to page E-28 for details.
- ★2. “N1: Plug-in Connector Type with Indicator Light” is not available for R type (AC→DC).
- ★3. Models for phosphate ester fluid are available. When phosphate ester fluid is used, prefix “F-” to the model number because the special seals (fluororubber) are required to be used.
- ★4. Special connector types, “ M12-4 Pin Connector Type ”, “ Center Plug-in Connector Type ”, “ Center Plug-in M12-4 Connector Type ”, “ Deutsch Connector Type ”, please refer to pages E-35 & E-36.

Attention

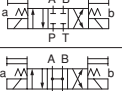
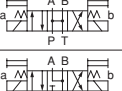
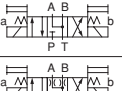
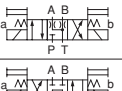
In the table above, the symbols or numbers highlighted with shade represent the optional extras. The valves with model number having such optional extras are handled as options, therefore, please confirm the time of delivery with us before ordering.

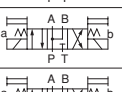
List of Standard Models

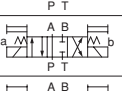
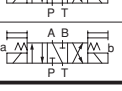
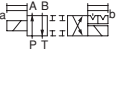
Models with AC Solenoids : DSG-01-* * *-A *

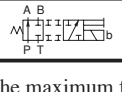
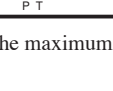
No. of Valve Positions	Spool-Spring Arrangement	Model Numbers	Graphic Symbols	Max. Flow L/min															
									 [Port "B" Blocked]					 [Port "A" Blocked]					
																			
				Working Pressure MPa					Working Pressure MPa					Working Pressure MPa					
		10	16	25	31.5	35	10	16	25	31.5	35	10	16	25	31.5	35			
Three Positions	Spring Centered	DSG-01-3C2		100	100	100	100	100	100 (43)	100 (41)	80 (21)	60 (17)	38 (15)	100 (43)	100 (41)	80 (21)	60 (17)	38 (15)	
		DSG-01-3C3		100 (80)	100 (80)	100 (80)	100 (77)	100 (77)	70 (46)	70 (46)	70 (46)	70 (46)	70 (46)	70 (46)	70 (46)	70 (46)	70 (46)	70 (46)	70 (46)
		DSG-01-3C4		90	90	90	90 (22)	35 (18)	100 (38)	76 (28)	67 (15)	57 (10)	35 (7)	100 (38)	76 (28)	67 (15)	57 (10)	35 (7)	
		DSG-01-3C40		85	85	85	80 (40)	80 (22)	85 (40)	85 (35)	85 (24)	60 (16)	55 (12)	85 (40)	85 (35)	85 (24)	60 (16)	55 (12)	
		DSG-01-3C60		43 (23)	43 (23)	42 (23)	42 (23)	42 (23)	54 (32)	54 (32)	52 (32)	52 (32)	52 (32)	54 (32)	54 (32)	52 (32)	52 (32)	52 (32)	
		DSG-01-3C9		100	100	100	100	100	20	15	10	10	8	20	15	10	10	8	
		DSG-01-3C10		100	100	100 (63)	100 (33)	100 (27)	100 (50)	100 (37)	100 (20)	78 (16)	62 (13)	100 (50)	100 (37)	100 (20)	78 (16)	62 (13)	
		DSG-01-3C11		100	100	100	100	100	23	20	13	10	5	100 (65)	85 (52)	72 (45)	65 (34)	60 (27)	
		DSG-01-3C12		100	100	100 (63)	100 (33)	100 (27)	100 (50)	100 (37)	100 (20)	78 (16)	62 (13)	100 (50)	100 (37)	100 (20)	78 (16)	62 (13)	
Two Positions	No-Spring Detented	DSG-01-2D2		80	80	80	80	80	45	45	45 (21)	45 (16)	38 (13)	50	50 (45)	50 (42)	45 (40)	45 (40)	
		DSG-01-2B2		85	85	85	85	85	20	16	16	15	13	85 (63)	80 (50)	63 (40)	44 (32)	44 (32)	
	Spring Offset	DSG-01-2B3		70	70	70	70	70	50	50	50	50	50	80 (70)	80 (70)	80 (70)	80 (70)	80 (70)	
		DSG-01-2B8		—	—	—	—	—	26	17	13	11	10	80 (50)	70 (40)	60 (20)	45 (10)	30 (10)	
		DSG-01-2B8		—	—	—	—	—	26	17	13	11	10	35 (20)	23 (15)	15 (8)	10 (5)	7 (5)	

Notes: 1. The relation between the maximum flow in the table above and the frequency/voltage (within the serviceable voltage) is as shown below.

(Example)

The maximum flow rate is constant regardless of 50 Hz or 60 Hz and of any voltage variants within the serviceable voltage

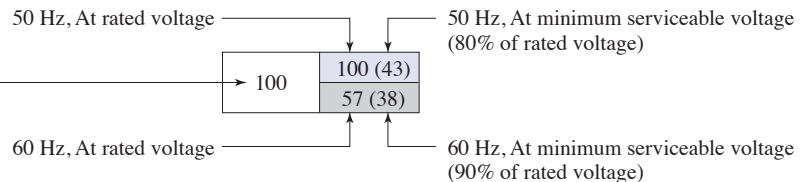









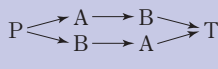
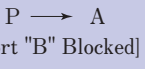
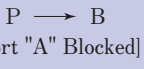







2. For the maximum flow rate in P → T of the valves with a ★ mark, please see page E-27.

The valve models with a ◆ mark are handled as options. If you choose such valves, check the time of delivery beforehand.

List of Standard Models

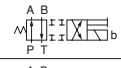
● Models with DC or R Type Solenoids : DSG-01- * * *-D*/R*

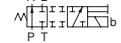
No. of Valve Positions	Spool-Spring Arrangement	Model Numbers	Graphic Symbols	Max. Flow L/min														
																		
																		
				Working Pressure MPa					Working Pressure MPa					Working Pressure MPa				
10 16 25 31.5 35					10 16 25 31.5 35					10 16 25 31.5 35								
Three Positions	Spring Centered	DSG-01-3C2		100	100	100	100	100	100	45	28	25	22	100	45	28	25	22
		DSG-01-3C3		100	100	100	100	100	78	78	78	78	75	78	78	78	78	75
		DSG-01-3C4		90	90	90	50	38	100	58	38	31	29	100	58	38	31	29
		DSG-01-3C40		85	85	65	40	33	85	52	30	26	24	85	52	30	26	24
		DSG-01-3C60★		50	50	50	50	50	66	66	66	66	66	66	66	66	66	66
		DSG-01-3C9		100	100	100	100	100	20	15	10	10	8	20	15	10	10	8
		DSG-01-3C10◆		85	85	85	80	40	100	56	36	28	24	100	56	36	28	24
		DSG-01-3C11◆		100	100	100	100	100	23	20	13	10	5	100	60	40	36	32
		DSG-01-3C12◆		85	85	85	80	40	100	56	36	28	24	100	56	36	28	24
Two Positions	No-Spring Detented	DSG-01-2D2		75	75	75	75	75	45	45	40	30	27	50	50	50	45	45
		70	70	70	70	70	30	25	22	45	42	40	40					
	Spring Offset	DSG-01-2B2		80	80	80	80	80	20	16	16	15	13	46	31	24	22	22
		DSG-01-2B3		70	70	70	70	70	50	50	50	50	50	75	75	75	75	75
		DSG-01-2B8		—	—	—	—	—	26	17	13	11	10	53	35	23	19	17

Notes: 1. The relation between the maximum flow in the table above and the voltage (within the serviceable voltage) is as shown below.

(Example)

The maximum flow rate is constant regardless of any voltage variants within the serviceable voltage



At rated voltage [after temperature rise and saturated]

At minimum serviceable voltage (90% of rated voltage) [after temperature rise and saturated]

2. For the maximum flow rate in P → T of the valves with a ★ mark, please see page E-27.

The valve models with a ◆ mark are handled as Options. If you choose such valves, check the time of delivery beforehand.

Maximum Flow Rate in P → T Flow

In valve type 3C60, in case where the actuator is put on in between the cylinder ports A and B as illustrated below and where the actuator moves and suspended at its stroke end and where the valve is then shifted to the neutral position in the suspended state of the actuator, the maximum flow rates available are those as shown as the table below regardless of any voltage in the range of serviceable voltage.

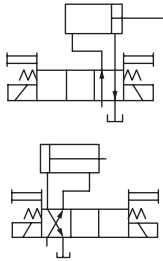

Model Numbers	Graphic Symbol	Max. Flow L/min				
		10 MPa	16 MPa	25 MPa	31.5 MPa	35 MPa
DSG-01-3C60-A*/D*/R*		55	44	30	26	22

List of Standard Models (Shockless Type)

- Models with DC or R Type Solenoids : S-DSG-01-* * *-D*/R*

No. of Valve Positions	Spool-Spring Arrangement	Model Numbers	Graphic Symbols	Max. Flow L/min								
				Working Pressure MPa			Working Pressure MPa			Working Pressure MPa		
				10	16	25	10	16	25	10	16	25
Three Positions	Spring Centered	S-DSG-01-3C2		63	63	40	40	32	25	32	20	16
		S-DSG-01-3C4		60	50	40	40	32	16	12	40	32
Two Positions	Spring Offset	S-DSG-01-2B2		50	45	45	30	30	30	60	40	40
				45	40	40						

Notes: The relation between the maximum flow in the table above and the voltage (within the serviceable voltage) is as shown below.

(Example)

The maximum flow rate is constant regardless of any voltage variants within the serviceable voltage

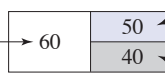

At rated voltage [after temperature rise and saturated]

At minimum serviceable voltage (90% of rated voltage) [after temperature rise and saturated]

Reverse Mounting of Solenoid

In spring offset type, it is a standard configuration that the solenoid is mounted onto the valve in the SOL b position (side). However, in this particular spool-spring arrangement, the mounting of the solenoid onto the valve in the reverse position -SOL a side- is also available. The graphic symbol for this reverse mounting is as shown below.

As for the valve type 2B*A and 2B*B, please refer to the explanation under the heading of "Valves Using Neutral Position and Side Position" given below.

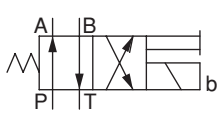

Standard Mtg. of Solenoid

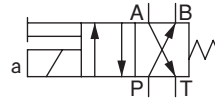
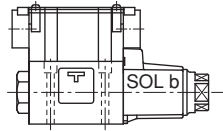

Reverse Mtg. of Solenoid

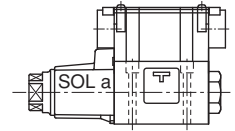

Valves Using Neutral Position and Side Position

Besides the use of the standard 2-position valves aforementioned in the "List of Standard Models", the 3-position valves also can be used as the 2-position valves using the two of their three positions. In this case, there are two kinds of the valve available. One is the valve using the neutral position and SOL a position (2B*A) and another is the valve using the neutral position and SOL b position (2B*B).

(Example) In case of Spool Type "2"

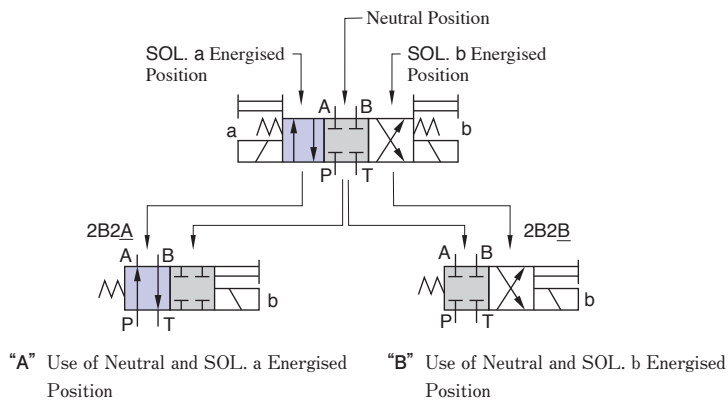

Model Numbers	Graphic Symbols	
	Standard Mtg. Type	Reverse Mtg. Type
DSG-01-2B * A		
DSG-01-2B2A		—

Model Numbers	Graphic Symbols	
	Standard Mtg. Type	Reverse Mtg. Type
DSG-01-2B * B		
DSG-01-2B2B		—
DSG-01-2B3B		—
DSG-01-2B4B		
DSG-01-2B60B		—
DSG-01-2B10B		—

In the above table, the graphic symbols in mounting type highlighted with shade are optional extra, therefore, please confirm the time of delivery with us before ordering.

Typical Changeover Time (Example)

Changeover time varies according to oil viscosity, spool type and hydraulic circuit.

Standard Type (Without Shockless Function)

[Test Conditions]

- Pressure : 16 MPa
- Flow Rate : 31.5 L/min
- Viscosity : 35 mm²/s
- Voltage : 100 %V at rated voltage
(After coil temperature rise and saturated)

[Result of Measurement]

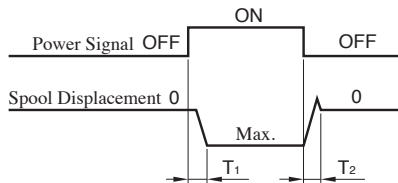

Type	Model Numbers	Time ms	
		T ₁	T ₂
Standard Type	DSG-01-3C2-A *	15	23
	DSG-01-3C2-D *	48	19
	DSG-01-3C2-R *	50	100

Shockless Type

[Test Circuit and Conditions]

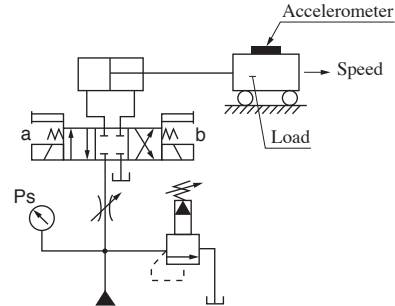

- Setting Pressure (Ps) : 7 MPa
- Load (W) : 1000 kg
- Cylinder Speed : 8 m/min
- Viscosity : 35 mm²/s

[Result of Measurement]

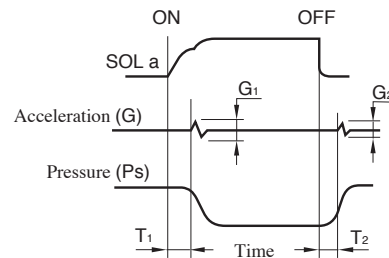

Type	Model Numbers	Time ms		Acceleration m/s ²	
		T ₁	T ₂	G ₁	G ₂
Shockless Type	S-DSG-01-3C2-D *	70	30	12	7
Reference: Standard Type	DSG-01-3C2-D *	35	25	18	15

Mounting Bolts

Mounting bolts are not available, please order separately.

Type/Dimension/Quantity

Item	Details	
Type	Soc. Hd. Cap Screw (SCM)	
Thread Size d	M5	
Thread Pitch P	mm	0.8
Bolt Length L	mm	45
Thread Length (Reference) b	mm	22
Quantity	4	

Specifications/Machinery Characteristics

Item	Details
Material	Steel SCM
Screw Type	Meter Coarse Screw
Finishing	Black Oxide Film
Class of Strength	12.9
Standard	Based on JIS B 1176(2014)

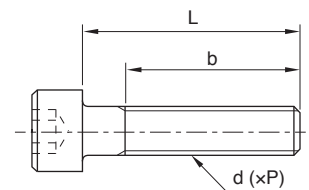

★If order to us, please use the model numbers below.

- MBK-01-05- *
- (* is the newest design number)

Pressure Drop

Pressure drop curves based on viscosity of 35 mm²/s and specific gravity of 0.850.

Standard Type

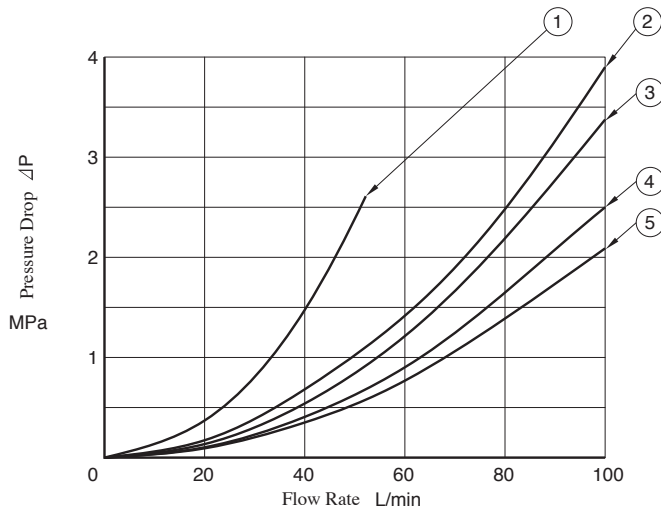

Model Numbers	Pressure Drop Curve Number				
	P→A	B→T	P→B	A→T	P→T
DSG-01-3C2	④	④	④	④	—
DSG-01-3C3	⑤	⑤	⑤	⑤	②
DSG-01-3C4	④	④	④	④	—
DSG-01-3C40	④	④	④	④	—
DSG-01-3C60	①	①	①	①	②
DSG-01-3C9	⑤	③	⑤	③	—
DSG-01-3C10	④	⑤	④	④	—
DSG-01-3C11	④	④	④	④	—
DSG-01-3C12	④	④	④	⑤	—
DSG-01-2D2	⑤	④	⑤	④	—
DSG-01-2B2	⑤	④	⑤	④	—
DSG-01-2B3	⑤	⑤	⑤	⑤	—
DSG-01-2B8	⑤	—	④	—	—

Shockless Type : S-DSG-01

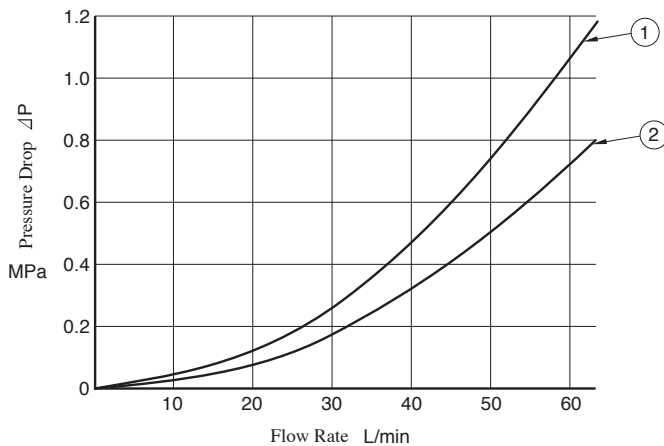

Model Numbers	Pressure Drop Curve Number			
	P→A	B→T	P→B	A→T
S-DSG-01-3C2	①	①	①	①
S-DSG-01-3C4	①	②	①	②
S-DSG-01-2B2	①	①	①	①

For any other viscosity, multiply the factors in the table below.

Viscosity mm ² /s	15	20	30	40	50	60	70	80	90	100
Factor	0.81	0.87	0.96	1.03	1.09	1.14	1.19	1.23	1.27	1.30

For any other specific gravity (G'), the pressure drop ($\Delta P'$) may be obtained from the formula below.
 $\Delta P' = \Delta P (G'/0.850)$

Mounting Surface: ISO 4401-03-02-0-05

Terminal Box Type (Standard)

- Models with AC Solenoids : **DSG-01-***-A***
- Spring Centered & No-Spring Detented

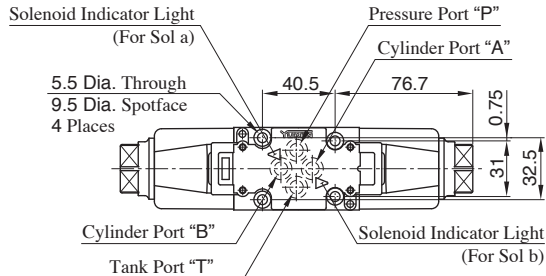

- Spring Offset

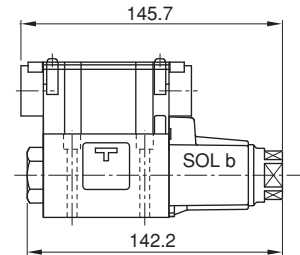

- For other dimensions, refer to the drawing left.
- Solenoid being mounted in the reverse position SOL a side is also available.

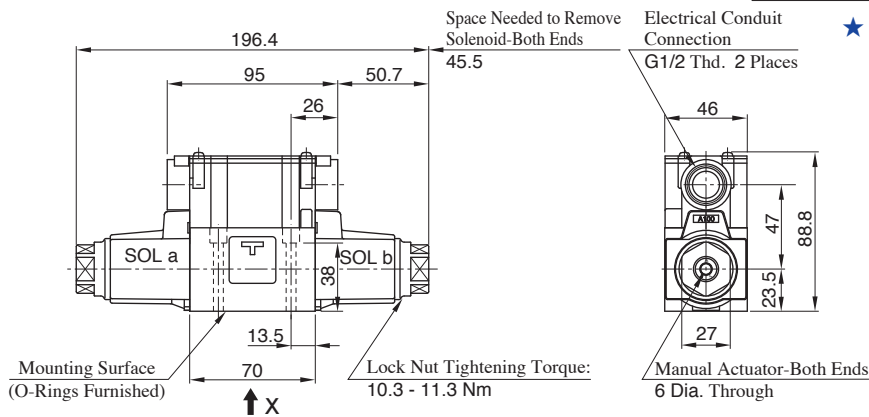

- Locating pin can be fitted to this hole to conform with ISO standard. Valve with locating pin is also available, please consult Yuken for details.

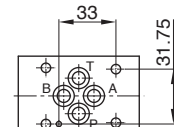

3 Dia. Through
5 Deep*
View Arrow X

- Models with DC Solenoids : **(S-) DSG-01-***-D***
- Models with R Type Solenoids : **(S-) DSG-01-***-R***
- Spring Centered / No-Spring Detented / Spring Offset

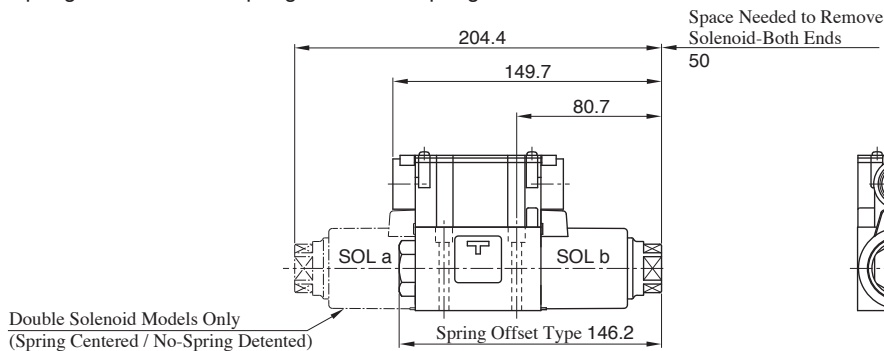

- For other dimensions, refer to models with AC solenoids drawing above.

Sub-plates : DSGM-01, 01X, 01Y

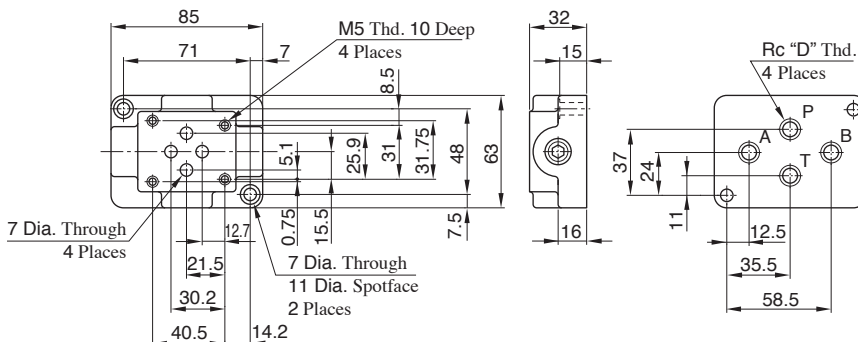

Sub-plate Model Numbers	D
DSGM-01-31	1/8
DSGM-01X-31	1/4
DSGM-01Y-31	3/8

Options

■ Plug-in Connector Type / Plug-in Connector with Indicator Light

- Models with AC Solenoids : **DSG-01-***-A*-N/N1**
- Models with DC Solenoids : **(S-) DSG-01-***-D*-N/N1**
- Models with R Solenoids : **(S-) DSG-01-***-R*-N**

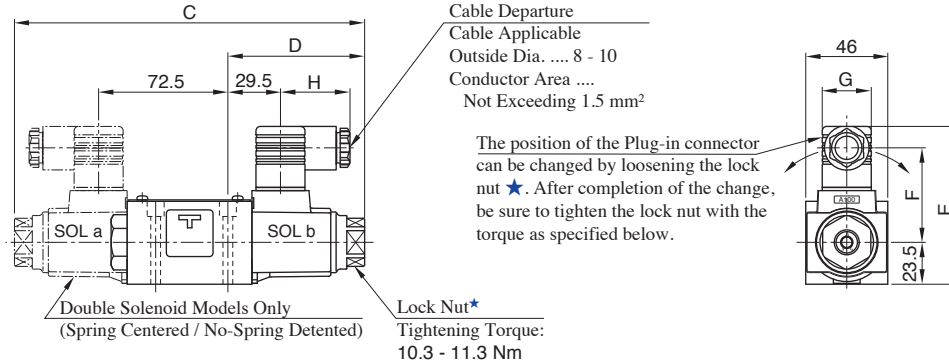

Model Numbers	C	D	E	F	G	H
DSG-01-***-A*-N*	196.4	76.7	88.5	53	27.5	39
(S-) DSG-01-***-D*-N*	204.4	80.7	99.5	64	27.5	39
(S-) DSG-01-***-R*-N	204.4	80.7	102.5	61.1	34	53

● For other dimensions, refer to "Terminal Box Type" (Page E-31).

■ Models with Push Button & Lock Nut
(S-) DSG-01-*-*-C**

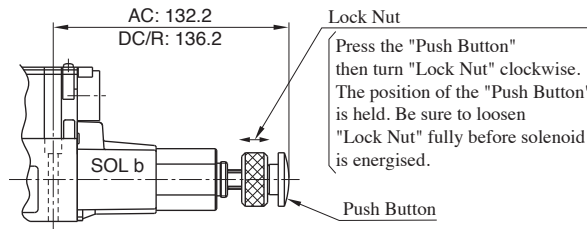

■ Interchangeability in Installation Current and New Design

In order to achieve higher pressure, higher flow, lower pressure drop and more compact, DSG-01 valves has been upgraded from the 60 design series to the 70 design series.

The figures in the table below are the comparison between current and new design valves.

● Specifications

Design Number	Max. Flow L/min	Max. Operating Pressure MPa	Max. Tank-Line Back Pres. MPa	Max. Changeover Frequency min ⁻¹	Pressure Drop* MPa	Mass kg	
						3C*/2D*	2B*
New Design : 70	100	35	21	300 (R Type sol. Only 120)	0.9	1.85	1.4
Current Design : 60	63	31.5	16		1.0	2.2	1.6

★Flow Rate: 60 L/min, Viscosity: 30 mm²/s, Spool type "2" (Closed center)

● The specifications of solenoid are not change between current and new designs.

● Interchangeability in Installation

Interchangeability in installation is maintained though there are minor differences in demension as in the following table.

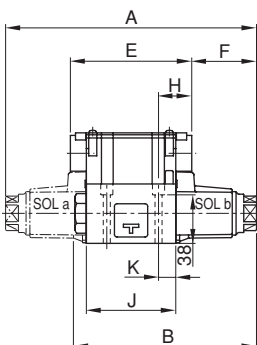

Solenoid Type	Design Number	A	B	C	D	E	F	H	J	K	L
AC	New Design : 70	196.4	142.2	46	88.8	95	50.7	26	70	13.5	70.5
	Current Design : 60	191.4	142.7	48	90.3	90	50.7	23.5	65	11	72
DC R	New Design : 70	204.4	146.2	46	88.8	95	54.7	26	70	13.5	70.5
	Current Design : 60	210	152	48	90.3	90	60	23.5	65	11	72

Electrical Conduit Connection

Details of Receptacle

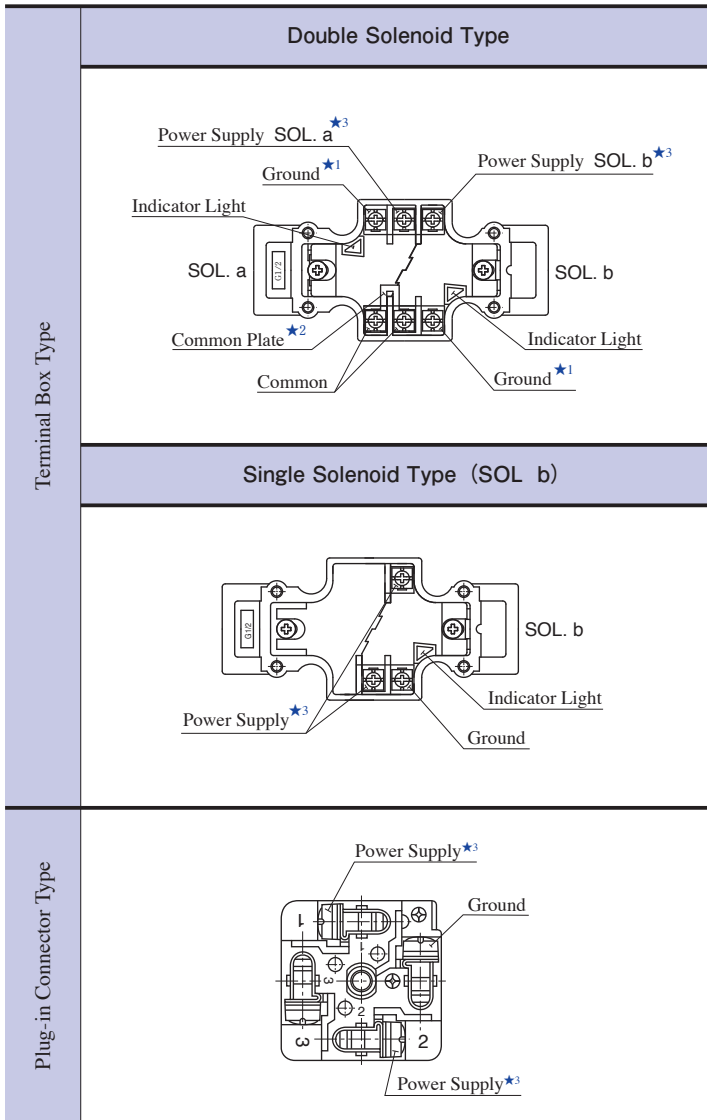

- ★1. There are two grounding terminals. You can use either one.
- ★2. If you do not need the common plate, remove it.
- ★3. With DC solenoids, polarity is no question.

⚠ DANGER

- Do not perform wiring while the power is on. Doing so may result in electric shock, burns or death.
- Make the wiring properly. Improper wiring will cause an irregular movement of the machine, resulting in a grave accident.

Electrical Circuit (Single Solenoid Type)

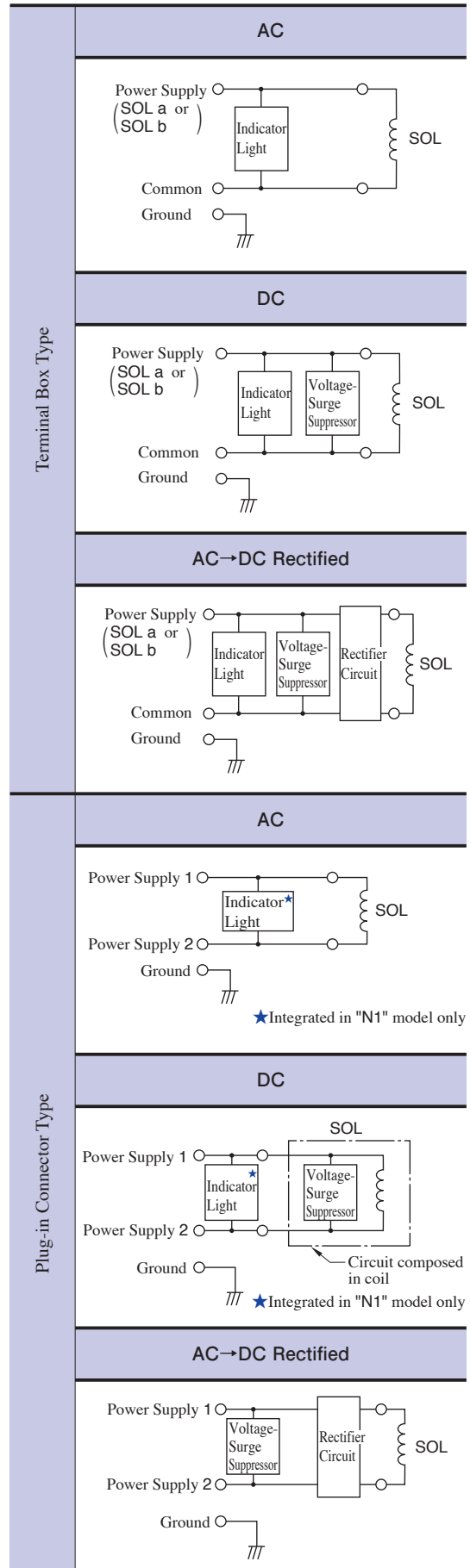

List of Seals and Solenoid Ass'y

(S-) DSG-01- * * *

Spring Offset type (2B*)

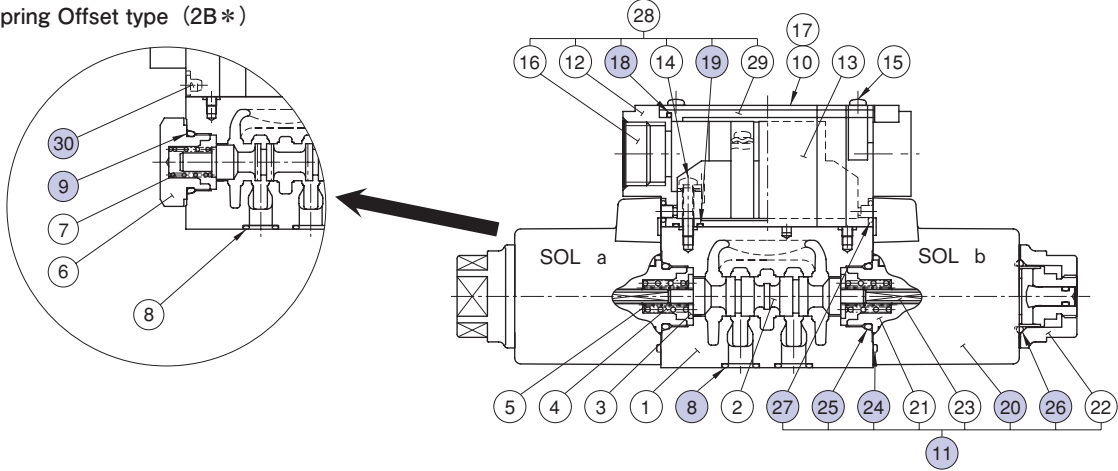

List of Seals

Item	Name of Parts	Part Numbers	Qty.			Remarks
			3C*	2D*	2B*	
8	O-Ring	AS 568-012 (NBR-90)	4	4	4	
9	O-Ring	OR NBR-90 P18-N	—	—	1	
18	Packing	1790S-VK421290-8	1	1	1	
19	O-Ring	S6	2	2	2	
24	O-Ring	AS 568-026 (NBR-70-1)	2	2	1	Included in Solenoid Ass'y (Item ⑪)
25	O-Ring	OR NBR-90 P18-N	2	2	1	
26	O-Ring	OR NBR-70-1 P20-N	2	2	1	
27	O-Ring	OR NBR-70-1 P4-N	4	4	2	
30	Plug	1790S-VK418329-9	—	—	2	

Solenoid Ass'y, Coil Ass'y No.

Model Numbers	⑪ Solenoid Ass'y No.	⑳ Coil Ass'y No.	Remarks
DSG-01- * * *-A100	SA1-100-70	C-SA1-100-70	Terminal Box Type
DSG-01- * * *-A120	SA1-120-70	C-SA1-120-70	
DSG-01- * * *-A200	SA1-200-70	C-SA1-200-70	
DSG-01- * * *-A240	SA1-240-70	C-SA1-240-70	
DSG-01- * * *-D12	SD1-12-70	C-SD1-12-70	
DSG-01- * * *-D24	SD1-24-70	C-SD1-24-70	
DSG-01- * * *-D48	SD1-48-70	C-SD1-48-70	
DSG-01- * * *-R100	SR1-100-70	C-SR1-100-70	
DSG-01- * * *-R200	SR1-200-70	C-SR1-200-70	Plug-in Connector Type
DSG-01- * * *-A100-N/N1	SA1-100-N-70	C-SA1-100-N-70	
DSG-01- * * *-A120-N/N1	SA1-120-N-70	C-SA1-120-N-70	
DSG-01- * * *-A200-N/N1	SA1-200-N-70	C-SA1-200-N-70	
DSG-01- * * *-A240-N/N1	SA1-240-N-70	C-SA1-240-N-70	
DSG-01- * * *-D12-N/N1	SD1-12-N-70	C-SD1-12-N-70	
DSG-01- * * *-D24-N/N1	SD1-24-N-70	C-SD1-24-N-70	
DSG-01- * * *-D48-N/N1	SD1-48-N-70	C-SD1-48-N-70	
DSG-01- * * *-R100-N	SR1-100-N-70	C-SR1-100-N-70	
DSG-01- * * *-R200-N	SR1-200-N-70	C-SR1-200-N-70	

As of solenoid Ass'y of shockless type and models with push button & lock nut, please order as below.

(Example)SD1-12-S-C-N-70

- C : Only for the models with push button & lock nut (option).
- S : Only for the models of shockless type.

Coil Ass'y numbers are same with those in above chart.

Special Electrical Conduit Connection

M12-4 Pin Connector Type

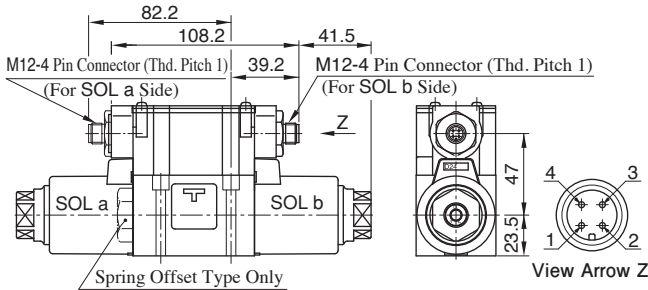

● For other dimensions, refer to page E-31 for Standard Terminal Box Type.

Pin No.

Terminal	Double Solenoid Type		Single Solenoid Type (Standard Mounting)		Single Solenoid Type (Reverse Mounting)	
	Common Minus PNP (Source)	Common Plus NPN (Sink)	Common Minus PNP (Source)	Common Plus NPN (Sink)	Common Minus PNP (Source)	Common Plus NPN (Sink)
①	Unused	Common(+)	Unused	Common(+)	Unused	Common(+)
②	SOL a	SOL a	Unused	Unused	SOL a	SOL a
③	Common(-)	Unused	Common(-)	Unused	Common(-)	Unused
④	SOL b	SOL b	SOL b	SOL b	Unused	Unused
Connector/Departure/Direction	M1: SOL b Side M2: SOL a Side	M3: SOL b Side M4: SOL a Side	M1: SOL b Side M2: Plug Side	M3: SOL b Side M4: Plug Side	M1: Plug Side M2: SOL a Side	M3: Plug Side M4: SOL a Side

Center Plug-in Connector Type

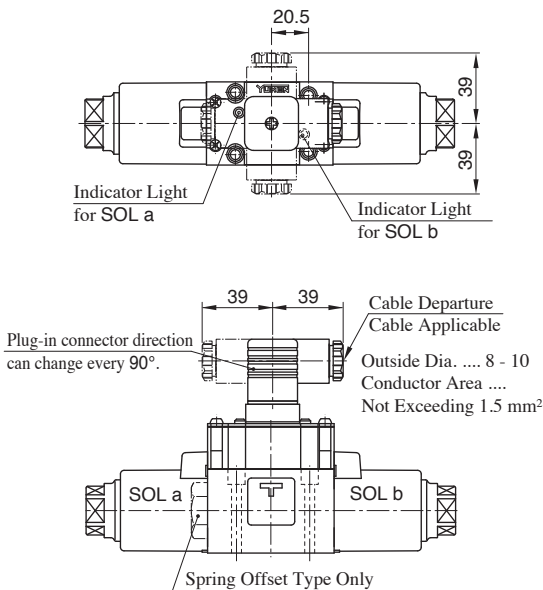

● For other dimensions, refer to page E-31 for Standard Terminal Box Type.

Model Numbers

DSG-01-2B2-D24-M1-70-L

↳ M12-4 Pin Connector Electrical Conduit Connection

- M1 : Load Side Common Minus (PNP Type) Terminal Box SOL b Side Conduit Connection
- M2 : Load Side Common Minus (PNP Type) Terminal Box SOL a Side Conduit Connection
- M3 : Load Side Common Plus (NPN Type) Terminal Box SOL b Side Conduit Connection
- M4 : Load Side Common Plus Terminal Box SOL a Side Conduit Connection

Coil numbers only for D12 and D24

● For other items, refer to page E-24 for Standard Model Number Designation.

Connection Circuit

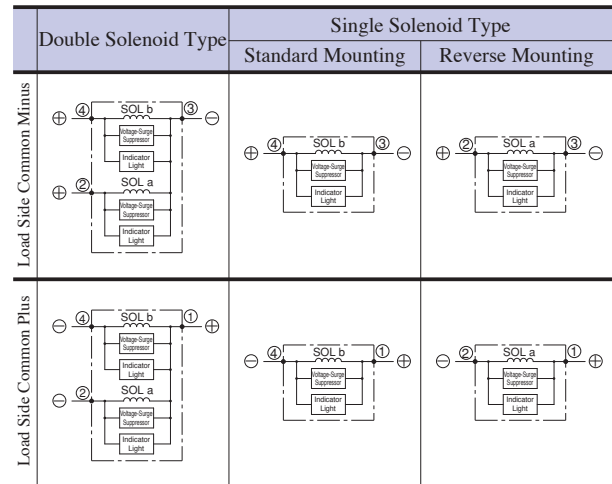

Model Numbers

DSG-01-2B2-D24-S-70-L

↳ Center Plug-in Connector

Electrical Conduit Connection Type

Coil Numbers Only for D12, D24, A100, A120, A200 & A240

● For other items, refer to page E-24 for Standard Model Number Designation.

Details of Receptacle

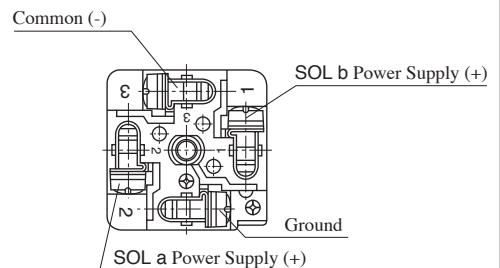

■ Center Plug-in Connector M12-4 Pin Connector Type Model Numbers

DSG-01-2B2-D24-S1-70-L

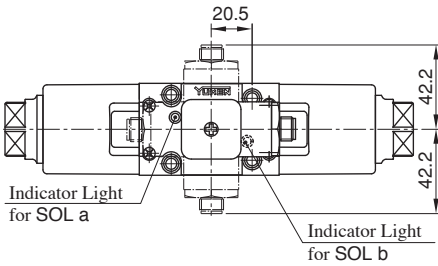

Center Plug-in M12 Connector 4 Pins Electrical Conduit Connection

- S1 : Load Side Common Minus (PNP Type)
- S2 : Load Side Common Plus (NPN Type)

Coil numbers only for D12 and D24

● For other items, refer to page E-24 for Standard Model Number Designation.

Plug-in connector direction can change every 90°.

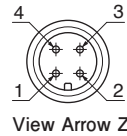
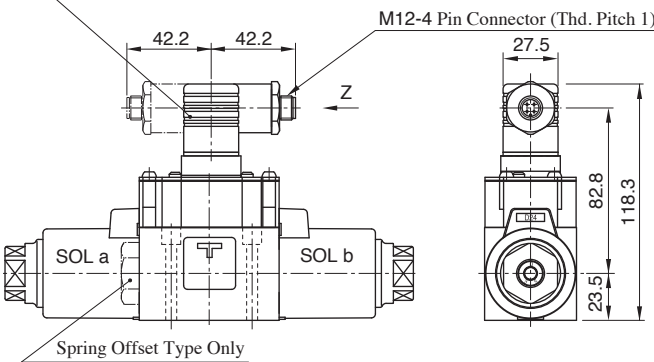

■ Connection Circuit

	Double Solenoid Type	Single Solenoid Type	
		Standard Mounting	Reverse Mounting
Load Side Common Minus			
Load Side Common Plus			

● For other dimensions, refer to page E-31 for Standard Terminal Box Type.

● Pin No.

Terminal	Double Solenoid Type		Single Solenoid Type (Standard Mounting)		Single Solenoid Type (Reverse Mounting)	
	Common Minus PNP (Source)	Common Plus NPN (Sink)	Common Minus PNP (Source)	Common Plus NPN (Sink)	Common Minus PNP (Source)	Common Plus NPN (Sink)
①	Unused	Common(+)	Unused	Common(+)	Unused	Common(+)
②	SOL a	SOL a	Unused	Unused	SOL a	SOL a
③	Common(-)	Unused	Common(-)	Unused	Common(-)	Unused
④	SOL b	SOL b	SOL b	SOL b	Unused	Unused

■ Deutsch Connector Type

Dust-proof / Water-proof property : IP67



Deutsch Connector
DEUTSCH Company Brand Equivalent Product

- Receptacle Body : DT04-2P-CE03
- Wedge : W2P
- Pin Contact : 0460-202-16141

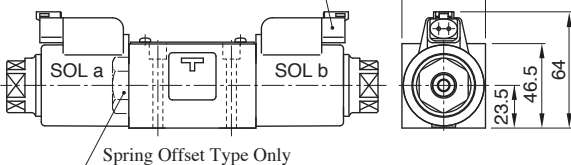

● For other dimensions, refer to page E-31 for Standard Terminal Box Type.

Model Numbers

DSG-01-2B2-D24-D-70-L

Deutsch Connector Electrical Conduit Connection

- D : No Diode
- D1 : Built-in Diode Type

Coil numbers only for D12 and D24

● For other items, refer to page E-24 for Standard Model Number Designation.

★ This valve needs another connector for electrical conduit connection.

The applicable connector as below.

Manufacturer : DEUTSCH Company

- Plug : DT06-2S-CE05
- Plug Wedge : W2S-P012
- Socket Contact : 0462-201-16141